

SF24 Configuration and Accessories

Mold Injection Connector (IP68 Factory Assembly Only)

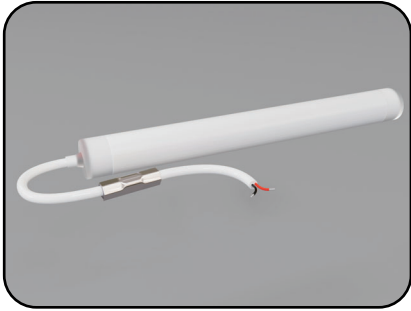

Direct Entry Connector
 MJ-SF24-A-D01/02/03
 MJ-SF24-A-D01SM
 MJ-SF24-A-D02SF
 MJ-SF24-A-D03SFM

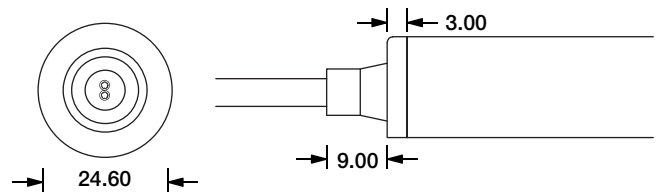

Side Entry Connector
 MJ-SF24-A-S01/02/03
 MJ-SF24-A-S01SM
 MJ-SF24-A-S02SF
 MJ-SF24-A-S03SFM

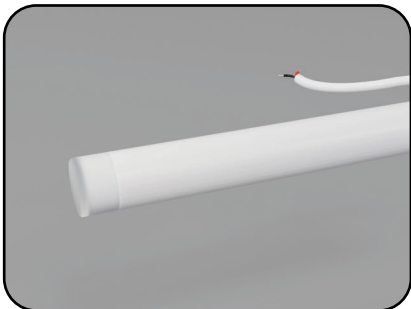
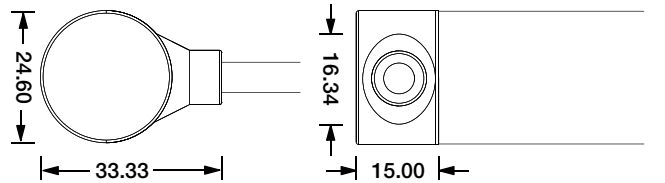

End Cap

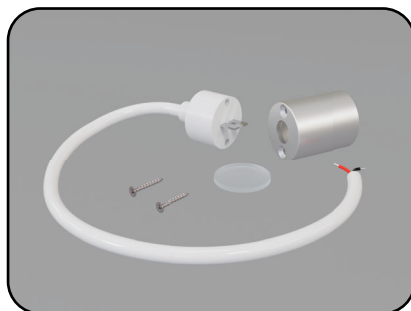
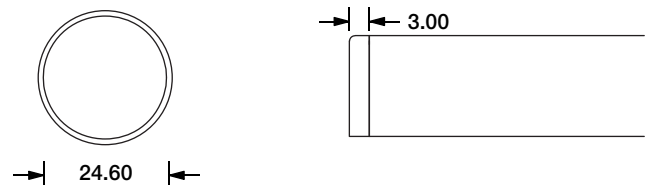

DIY Snap Front Connector
 DIY-SN-FR-24-A

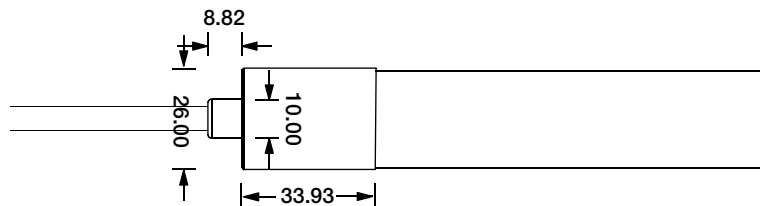

DIY End Cap Connector
 DIY-SN-END-24

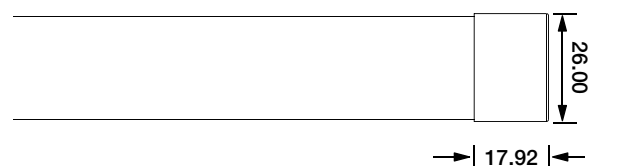

SF24 Configuration and Accessories

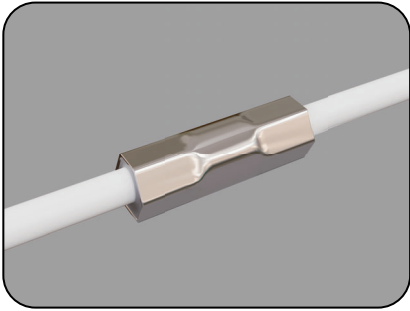

Waterproof Interrupter

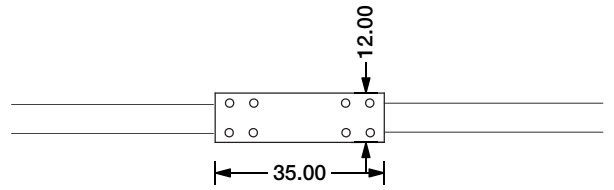

Male Connector

M12-M-2C-18AWG-D6- W-0327-S

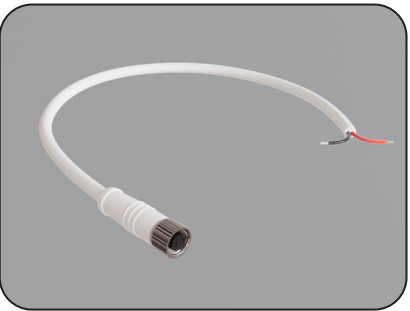
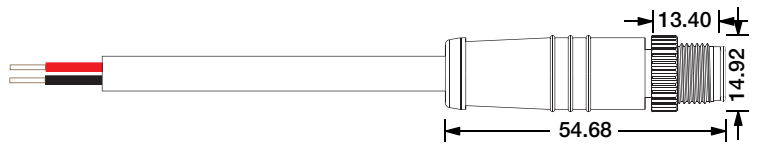

Female Connector

M12-F-2C-18AWG-D6- W-0327-S

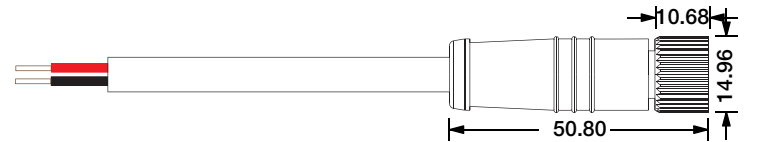

Pendant Accessories

SF24-PA

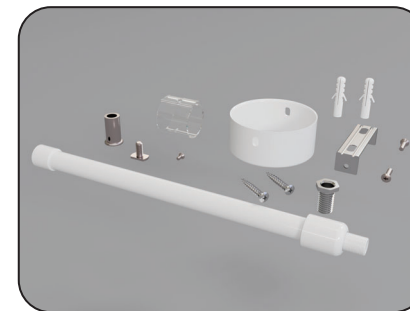

Metal base Mounting Accessories Kit

SF24-MB-TLR

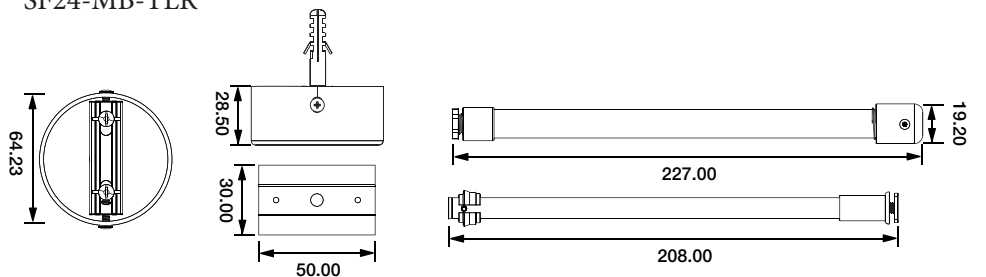

SF24 Configuration and Accessories

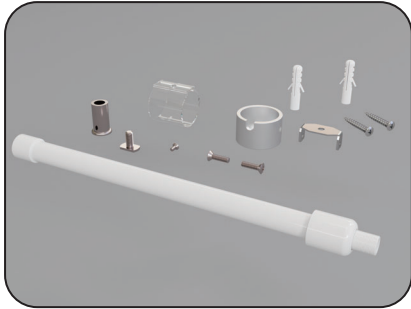

Aluminum alloy base Mounting Accessories Kit
SF24-AAB-TLR

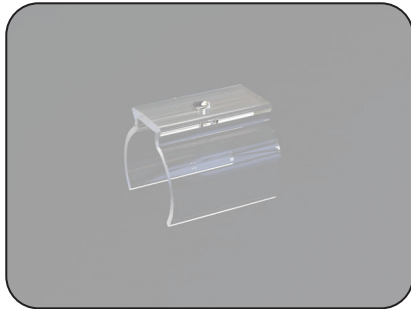
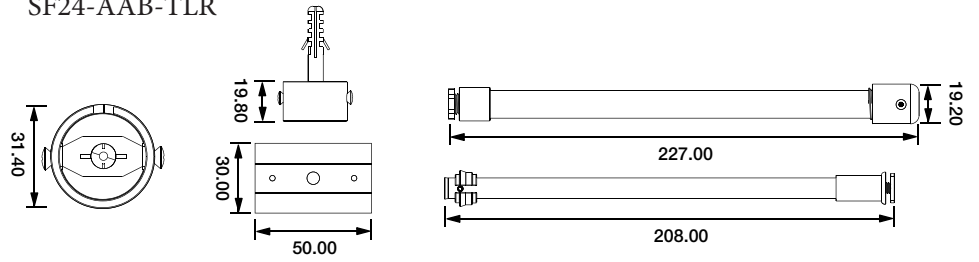

Mounting Plastic Clips
PC24S01-T-03

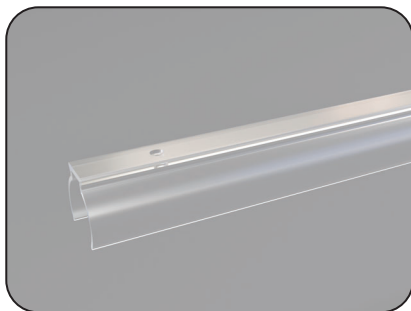
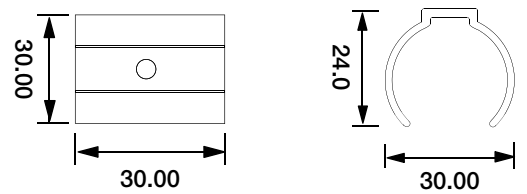

Mounting Plastic Channel
PC24S01-T-100

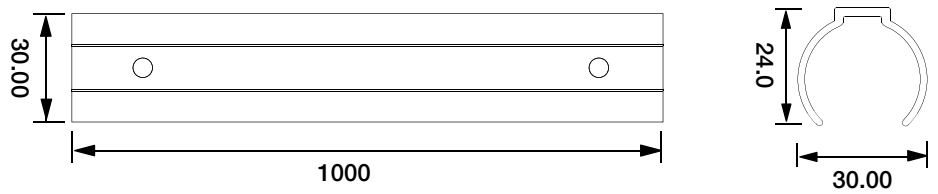

Mounting Connective Plastic Clips
PC24S02-T-05

