

T18 Configuration and Accessories

Mold Injection Connector (IP68 Factory Assembly Only)

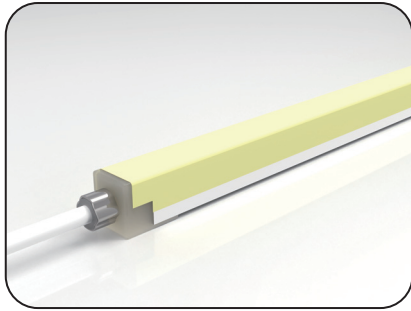

Direct Entry Connector
 MJ-18-A-D01/02/03
 MJ-18-A-D01SM
 MJ-18-A-D02SF
 MJ-18-A-D03SFM

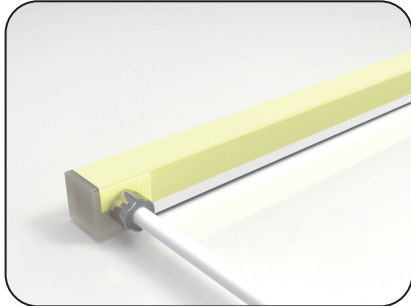
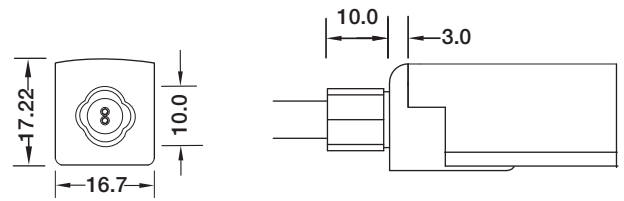

Side Entry Connector
 MJ-18-A-S01/02/03
 MJ-18-A-S01SM
 MJ-18-A-S02SF
 MJ-18-A-S03SFM

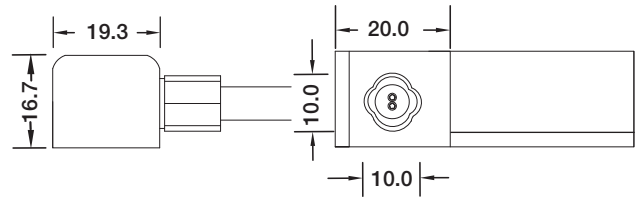

Bottom Entry Connector
 MJ-18-A-S01/02/03
 MJ-18-A-S01SM
 MJ-18-A-S02SF
 MJ-18-A-S03SFM

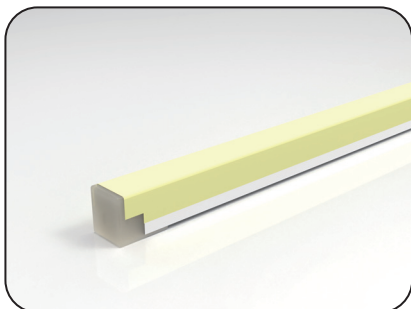
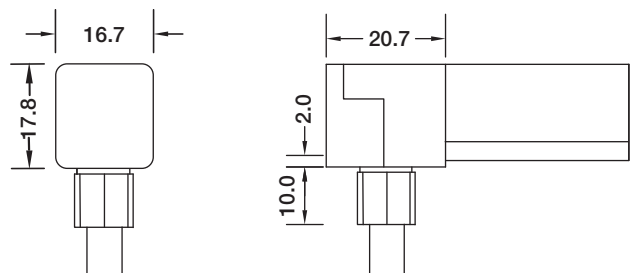

End Cap

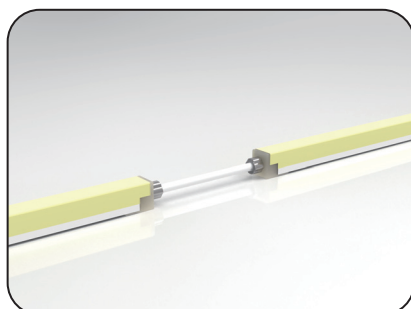
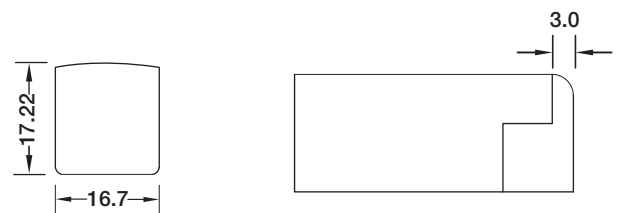

Jumper
 MJ-18-A-D-JC

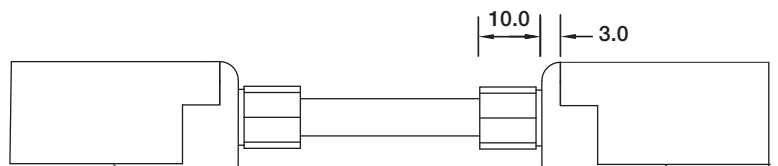

T18 Configuration and Accessories

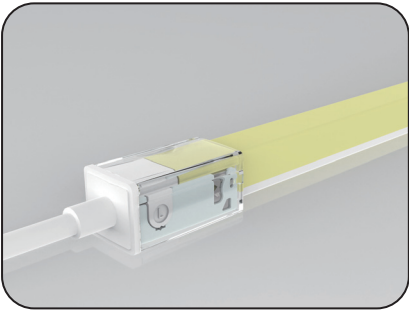

DIY Snap Connector
DIY-SN-FR-16-D-01/02-A

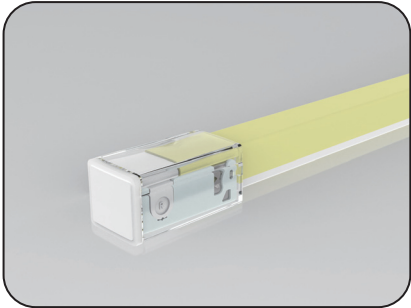
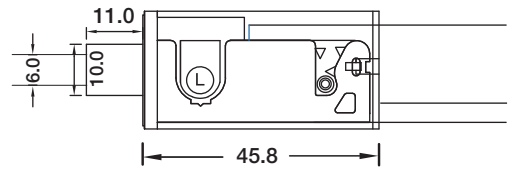
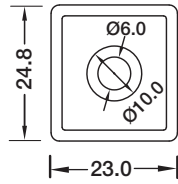

DIY Snap End Cap
DIY-SN-END-16-D-01/02

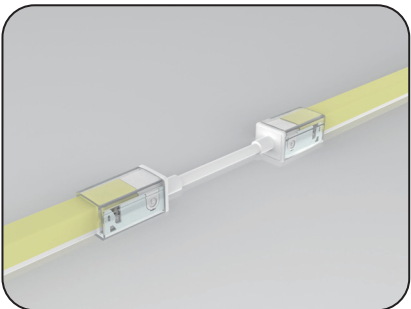
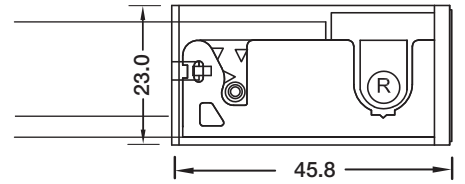
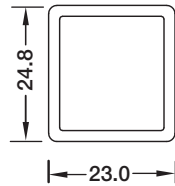

DIY Snap Connector Jumper
DIY-SN-FR-16-A-D-JC

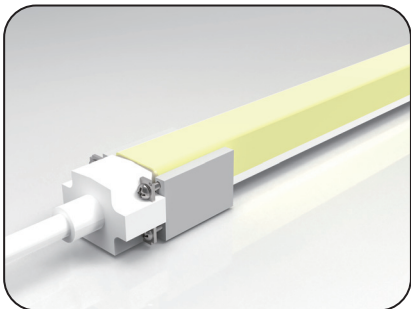
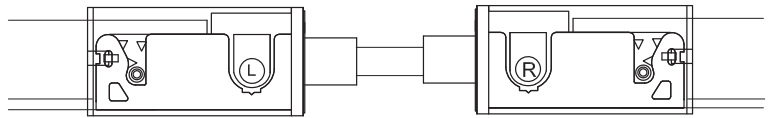

DIY Screw Connector
DIY-SC-FR-16-D-01/02-A

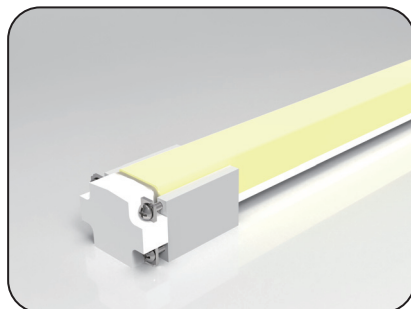
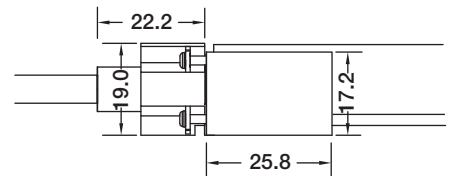
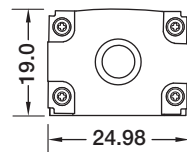

DIY Screw Connector
DIY-SC-END-16

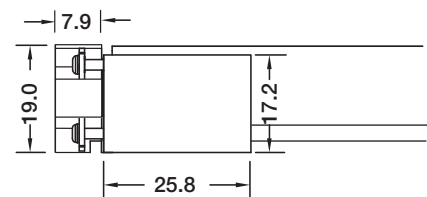
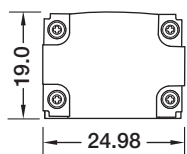

T18 Configuration and Accessories

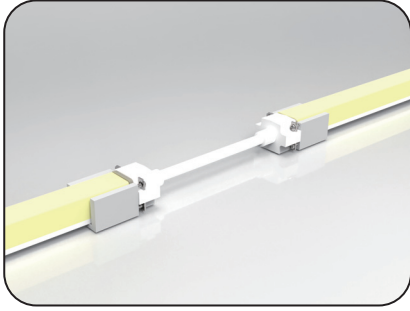

DIY Screw Extension Connector
DIY-SC-EXT-16-A

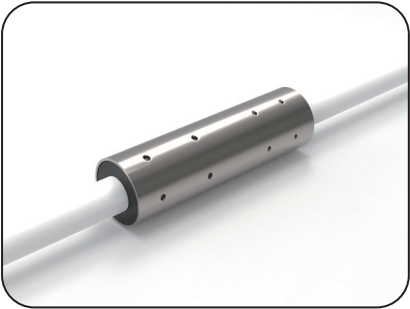
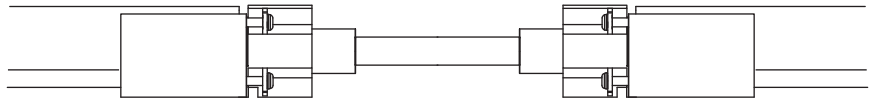

Waterproof Interrupter

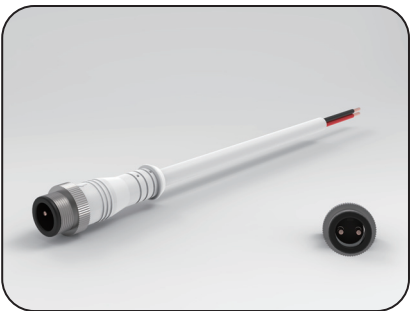
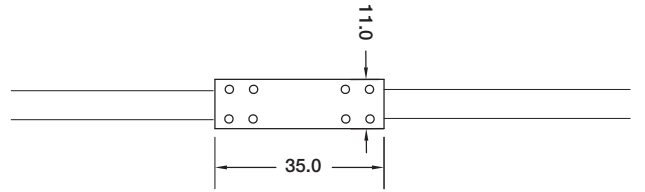

Male Connector
SYZ-M12-M-2C-075-W

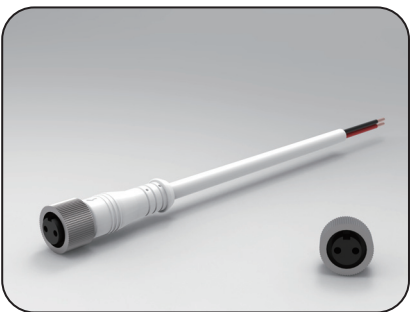
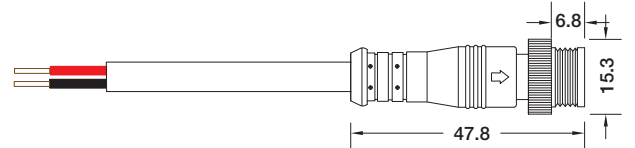

Female Connector
SYZ-M12-F-2C-075-W

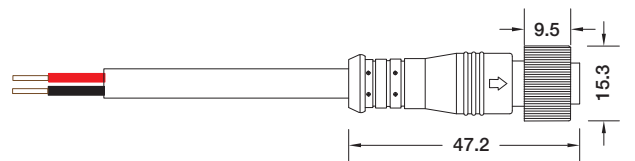

LED linear Flex Mounting Channel

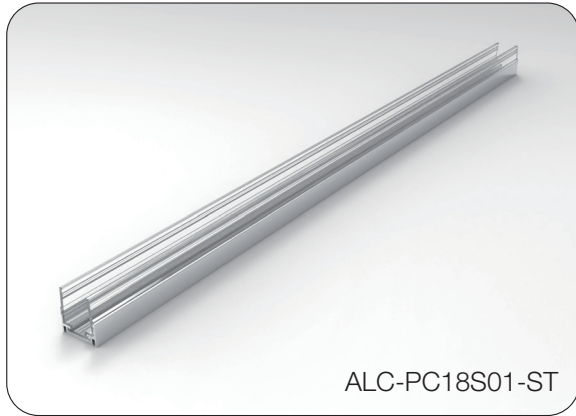

Dimension

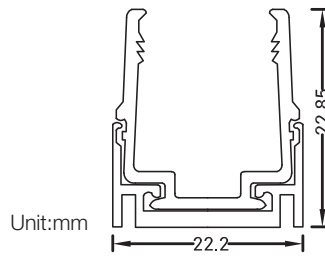

Installation Way

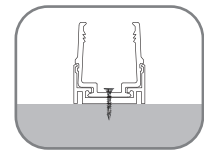

Surface Mounted

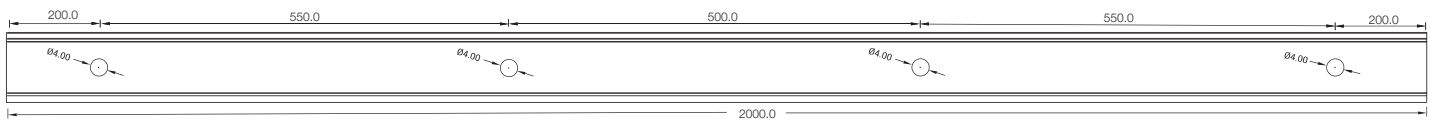
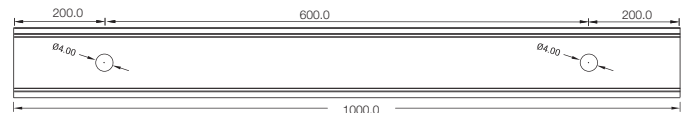
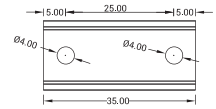

Model	W x H(mm)	Standard Length	Screw Holes	Holes Numbers	Suitable Product
ALC-PC18S01-ST	22.2*22.85	35mm	Φ4.0mm	2	T16, S17, T18, SF16, SF17, SF18
		1000mm	Φ4.0mm	2	T16, S17, T18, SF16, SF17, SF18
		2000mm	Φ4.0mm	4	T16, S17, T18, SF16, SF17, SF18

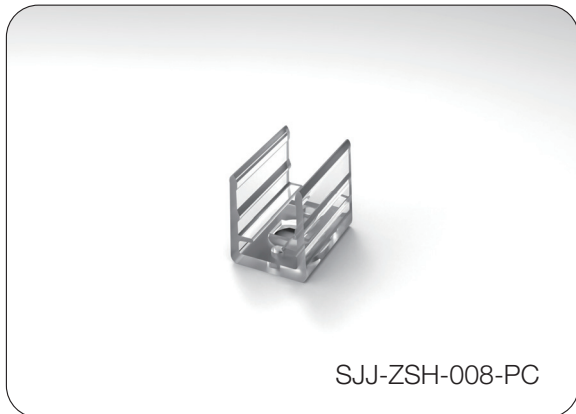

Dimension

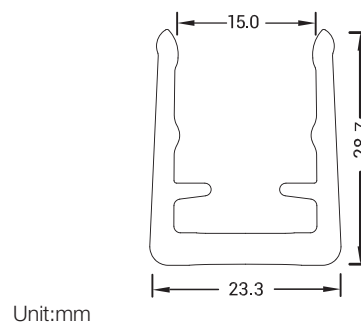

Installation Way

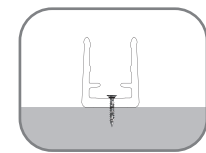

Surface Mounted

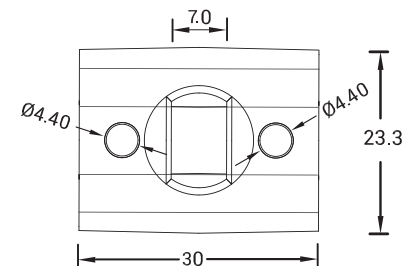

Model	W x H(mm)	Standard Length	Screw Holes	Holes Numbers	Suitable Product
SJJ-ZSH-008-PC	23.3*28.7	30mm	Φ4.40mm	2	T16, S17, T18, SF16, SF17, SF18

LED linear Flex Packing Details

Standard: Carton (Paper Reel Inside)



Product	Max.Length	Carton Size	Net Weight	Gross Weight
S15/SF15	30m	34*34*18cm	12kg	13.6kg
T16/SF16	20m	34*34*18cm	8.6kg	10.2kg
S17/SF17	20m	34*34*18cm	8.6kg	10.2kg
T18/SF18	20m	34*34*18cm	8.6kg	10.2kg
S21/SF21	20m	34*34*18cm	10.4kg	12.0kg
T10/SF10	30m	34*34*18cm	9.6kg	11.2kg
S09/SF09	35m	34*34*18cm	5.8kg	7.4kg
S08/SF08	30m	34*34*18cm	7.2kg	8.8kg
S06/SF06	30m	34*34*18cm	7.2kg	8.8kg

Custom: Carton (White Box+ Plastic Plate Inside)



Product	Package 1 Dimension	Length	Gross Weight	Package 2 Dimension	Length	Gross Weight
S15/SF15	38*38*3cm	5m	2.5kg	45*55*3cm	10m	5kg
T16/SF16	38*38*3cm	5m	2.6kg	51*61*4cm	10m	5.2kg
S17/SF17	38*38*3cm	5m	2.6kg	51*61*4cm	10m	5.2kg
T18/SF18	38*38*3cm	5m	2.6kg	51*61*4cm	10m	5.2kg
S21/SF21	38*38*3cm	5m	3.1kg	51*61*4cm	10m	6.2kg
T10/SF10	38*38*3cm	5m	2.0kg	45*55*3cm	10m	4kg
S09/SF09	38*38*3cm	5m	1.5kg	45*55*3cm	10m	3kg
S08/SF08	38*38*3cm	5m	1.5kg	45*55*3cm	10m	3kg
S06/SF06	38*38*3cm	5m	1.5kg	45*55*3cm	10m	3kg