

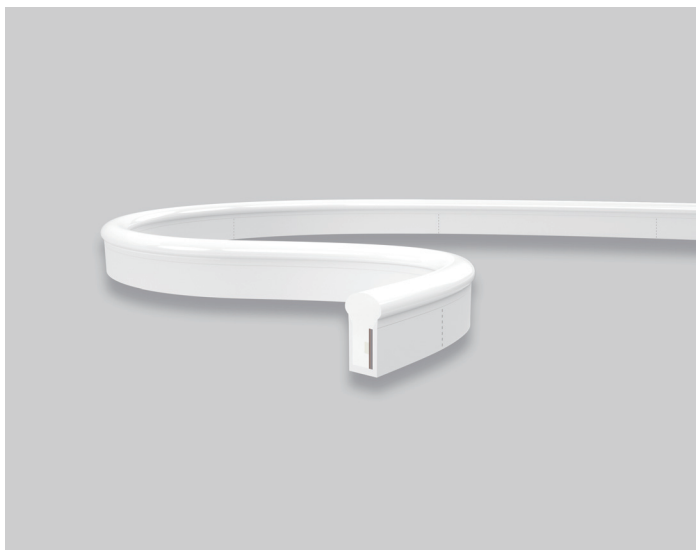











SF21 Mono Color Silicone LED Linear Flex

SF21-48V-5050-60-2200K-6500K

Specification



Technical Parameters

Electrical		Optional Color	Lumen Output
Input Voltage	48V DC	 2200K(2238±102K)	320m/m
Power Consumption	10W/m	 2700K(2725±145K)	320lm/m
Physical			
LED Count	60 LEDs/m	 3000K(3045±175K)	340lm/m
Cutting Unit	15 LEDs	 3500K(3465±245K)	340lm/m
Cutting Unit Length	250mm	 4000K(3985±275K)	340lm/m
Minimum Bend Diameter	80mm	 4500K(4503±243K)	320lm/m
Output			
LED Light	Epistar SMD LED 3528	 5000K(5029±283K)	320lm/m
CRI	>80, >90	 6500K(6532±510K)	320lm/m
Max Run Length*		 Green(520-530nm)	200lm/m
Single Feed	20M	 Blue (520-530nm)	35lm/m
Double Feed	40M	 Lemon Yellow(520-530nm)	360lm/m
Beam Angle	270°	 Pink(630-645nm)	240lm/m
Lumen Maintenance	70,000 Hours L70 @ 25°C 50,000 Hours L70 @ 50°C		
Temperature Ranges			
Installation	0°C to 50°C		
Operating	-40°C to 55°C		
Dependability			
Warranty	5 Years Warranty		
IP Rating	IP68 Wet location submersible <2m		

Illuminance Distribution

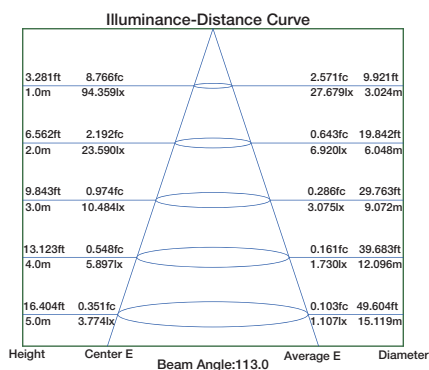
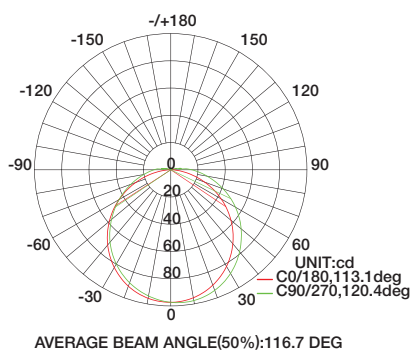

White Color Charts

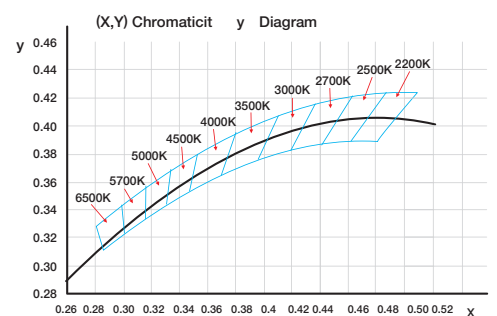

SF21 Mono Color Silicone LED Linear Flex

Connection

