

# SF15 Mono Color Silicone LED Linear Flex

SF15-48V-5050-60-2200K-6500K

## Specification

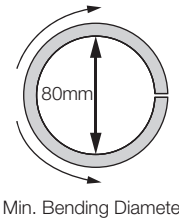
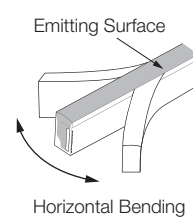
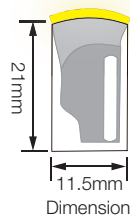
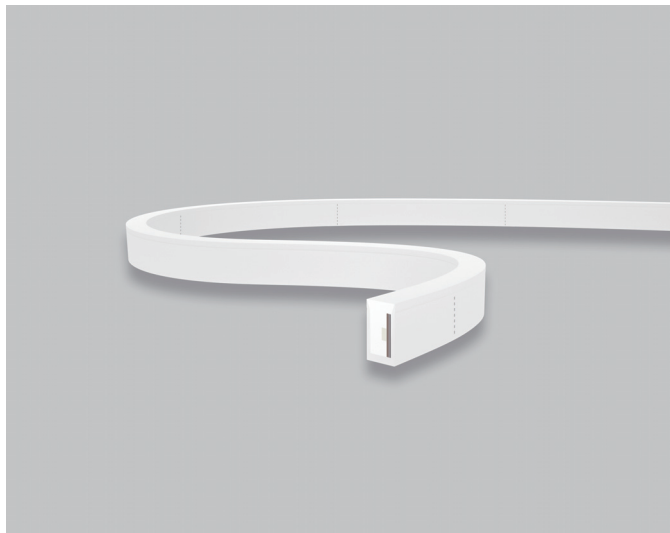

Beam Angle	Ansi C78.377	4 SDCM	One Bin	Dimmable	Submersible
Ambient Temp.	Class 3	LM-80	IK08	UV Resistant	Anti-Yellowing
Flame Resistant	Saltwater Resistant	Solvents Resistant	Dirt Resistant	CE	RoHS
5 years warranty Warranty					

## Technical Parameters

Electrical	Optional Color	Lumen Output
Input Voltage	2200K(2238±102K)	300lm/m
Power Consumption	2700K(2725±145K)	300lm/m
<b>Physical</b>		
LED Count	3000K(3045±175K)	320lm/m
Cutting Unit	3500K(3465±245K)	320lm/m
Cutting Unit Length	4000K(3985±275K)	340lm/m
Minimum Bend Diameter	4500K(4503±243K)	340lm/m
<b>Output</b>		
LED Light	5000K(5029±283K)	360lm/m
CRI	6500K(6532±510K)	360lm/m
Max Run Length*	Green(520-530nm)	190lm/m
Single Feed	Blue (520-530nm)	35lm/m
Double Feed	Lemon Yellow(520-530nm)	260lm/m
Beam Angle	Pink(630-645nm)	150lm/m
Lumen Maintenance		
		70,000 Hours L70 @ 25°C
		50,000 Hours L70 @ 50°C
<b>Temperature Ranges</b>		
Installation		0°C to 50°C
Operating		-25°C to 50°C
<b>Dependability</b>		
Warranty		3 Years Warranty
IP Rating		IP68 Wet location submersible <2m

## Illuminance Distribution

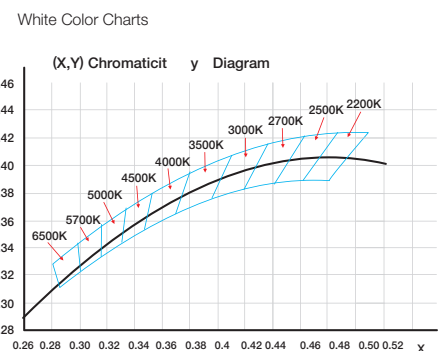
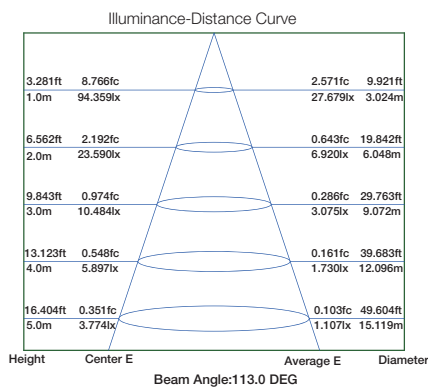
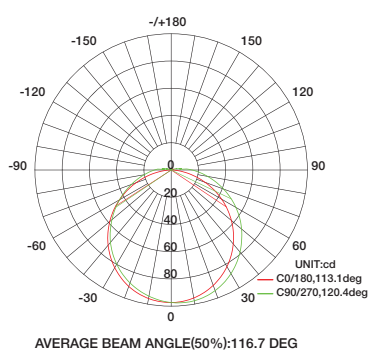

# SF15 Mono Color Silicone LED Linear Flex

## Connection

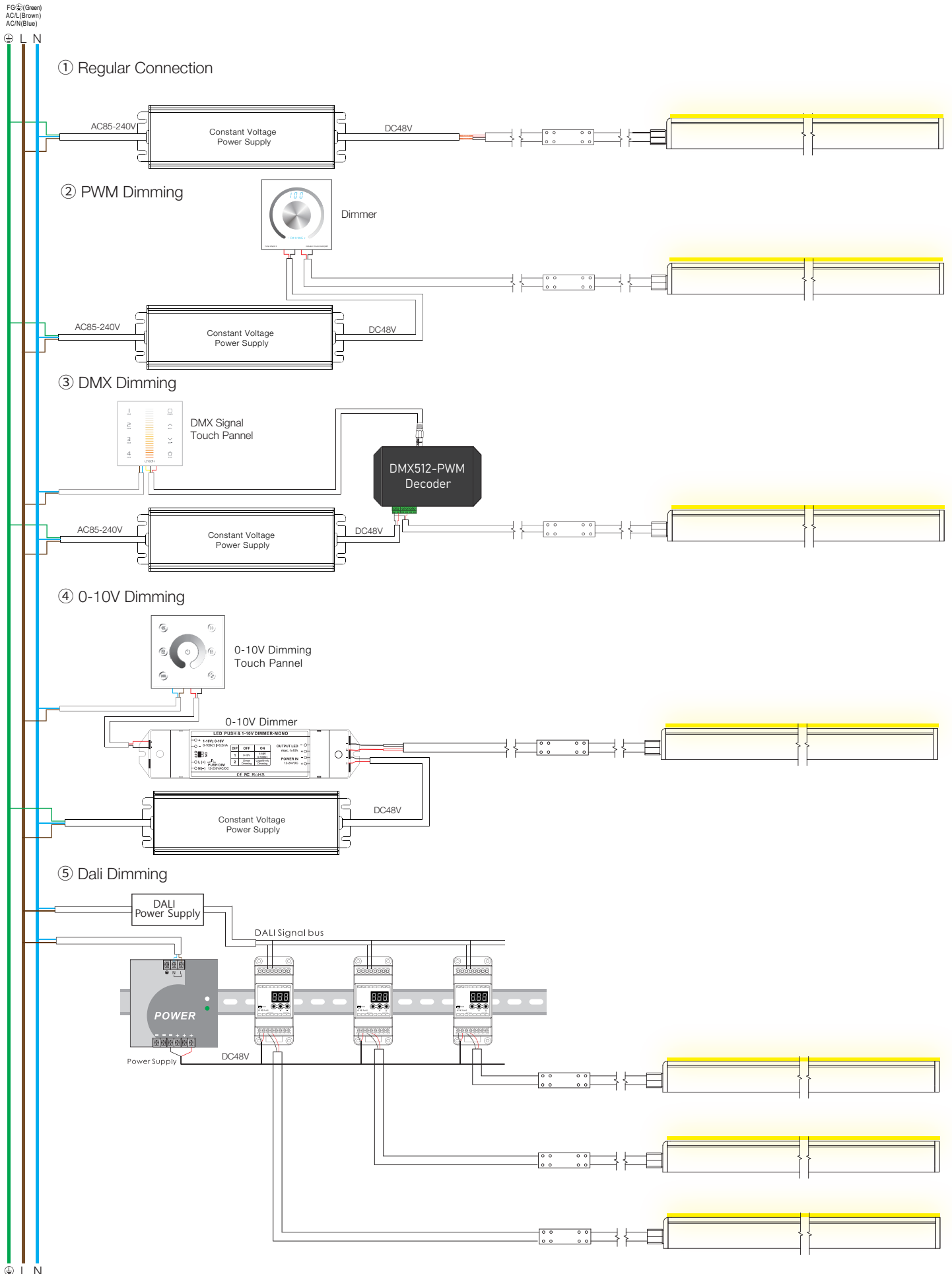

L N