

# S17 Configuration and Accessories

Mold Injection Connector (IP68 Factory Assembly Only)

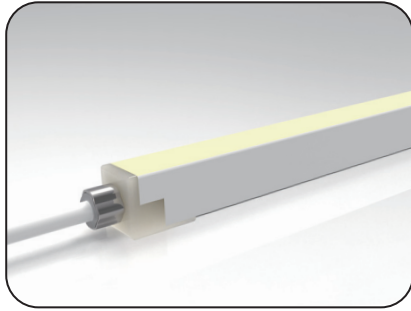

Direct Entry Connector  
 MJ-17-A-D01/02/03  
 MJ-17-A-D01SM  
 MJ-17-A-D02SF  
 MJ-17-A-D03SFM

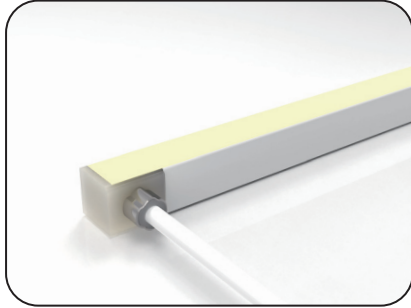
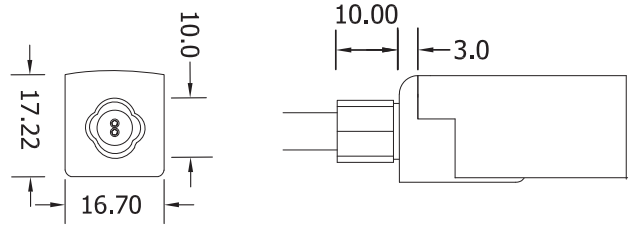

Side Entry Connector  
 MJ-17-A-S01/02/03  
 MJ-17-A-S01SM  
 MJ-17-A-S02SF  
 MJ-17-A-S03SFM

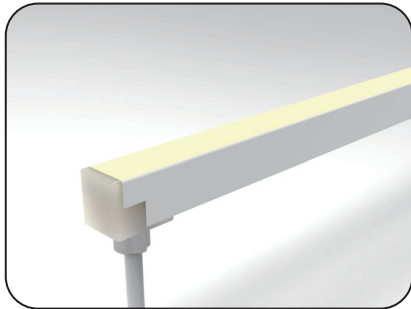
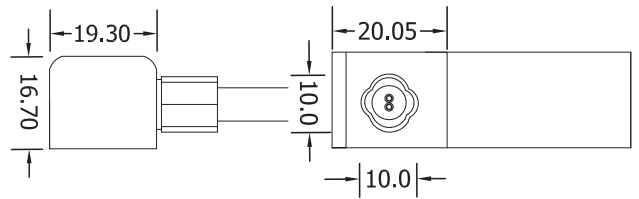

Bottom Entry Connector  
 MJ-17-A-S01/02/03  
 MJ-17-A-S01SM  
 MJ-17-A-S02SF  
 MJ-17-A-S03SFM

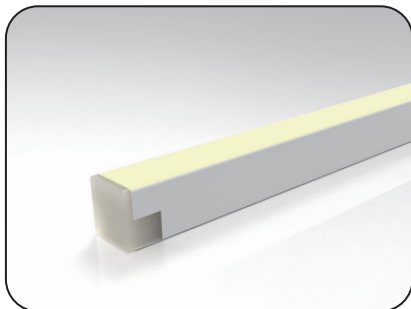
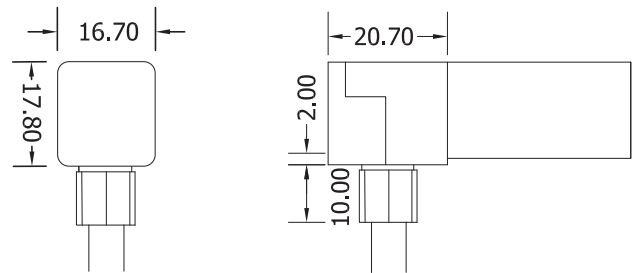

End Cap

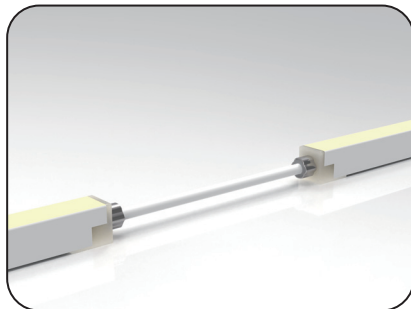
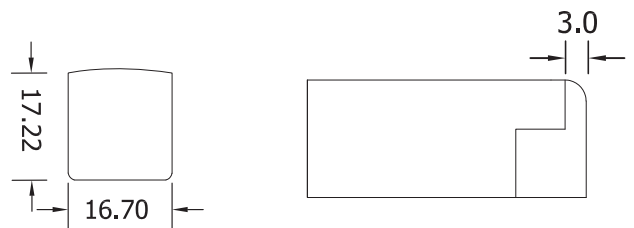

Jumper  
 MJ-17-A-D-JC

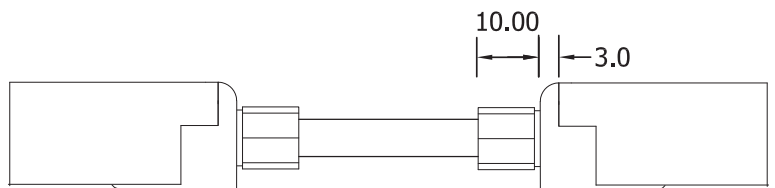

# S17 Configuration and Accessories

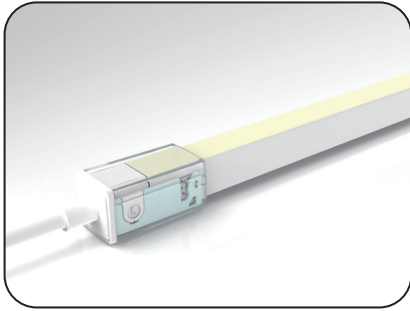

DIY Snap Connector  
DIY-SN-FR-17-D-01/02-A

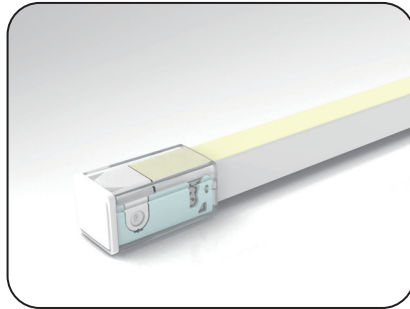
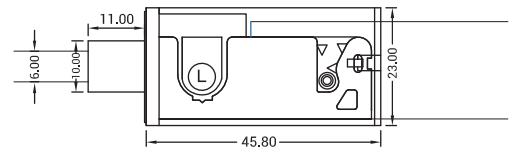
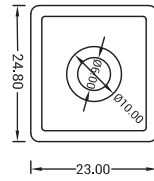

DIY Snap End Cap  
DIY-SN-END-17-D-01/02

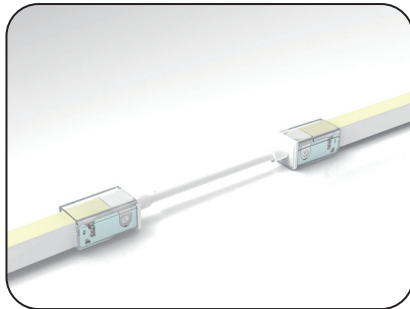
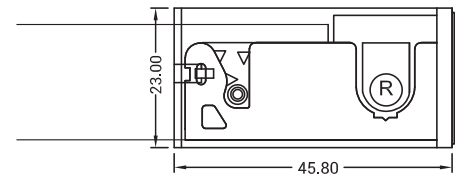
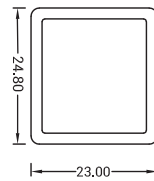

DIY Snap Connector Jumper  
DIY-SN-FR-17-A-D-JC

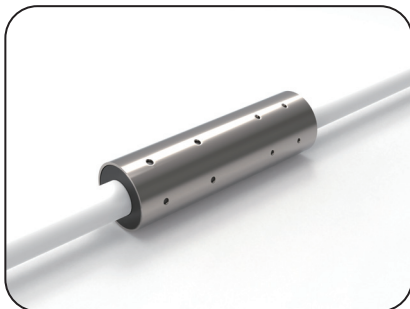
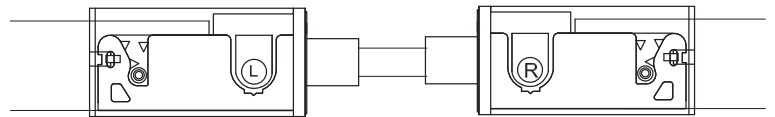

Waterproof Interrupter

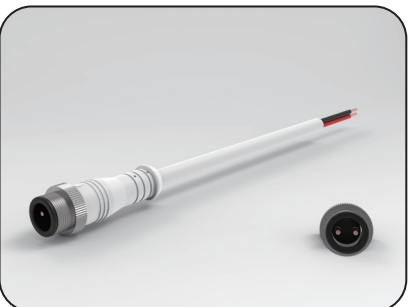
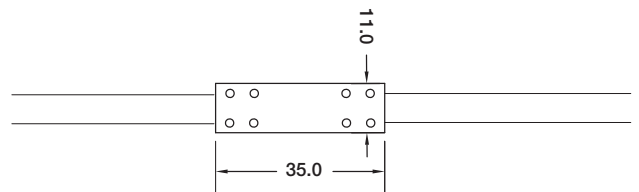

Male Connector  
SYZ-M12-M-2C-075-W

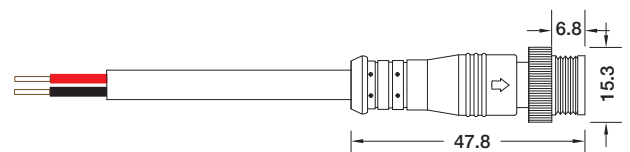

# S17 Configuration and Accessories

---

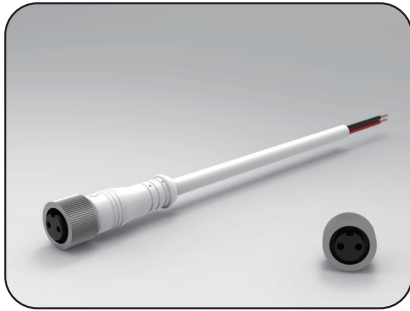

Female Connector  
SYZ-M12-F-2C-075-W

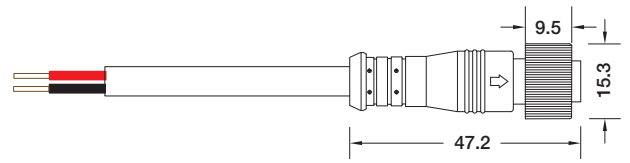

# LED linear Flex Mounting Channel

## 1. Aluminum Channel

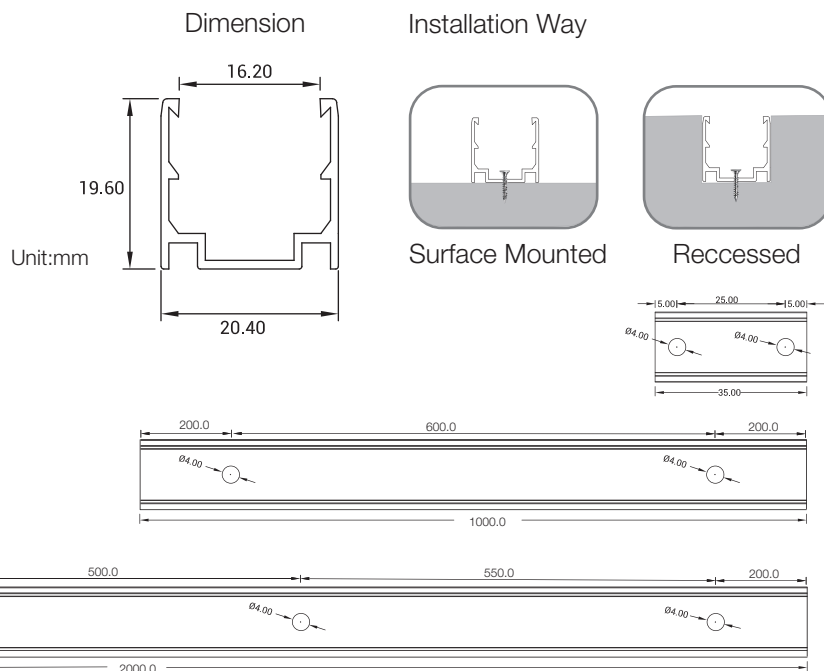
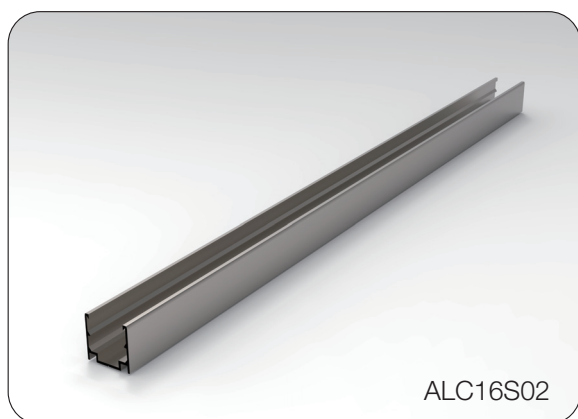

Model	W x H(mm)	Standard Length	Screw Holes	Holes Numbers	Suitable Product
ALC16S02	20.4*19.6	35mm	Φ4.0mm	2	T16, S17, SF16, SF17
		1000mm	Φ4.0mm	2	T16, S17, SF16, SF17
		2000mm	Φ4.0mm	4	T16, S17, SF16, SF17

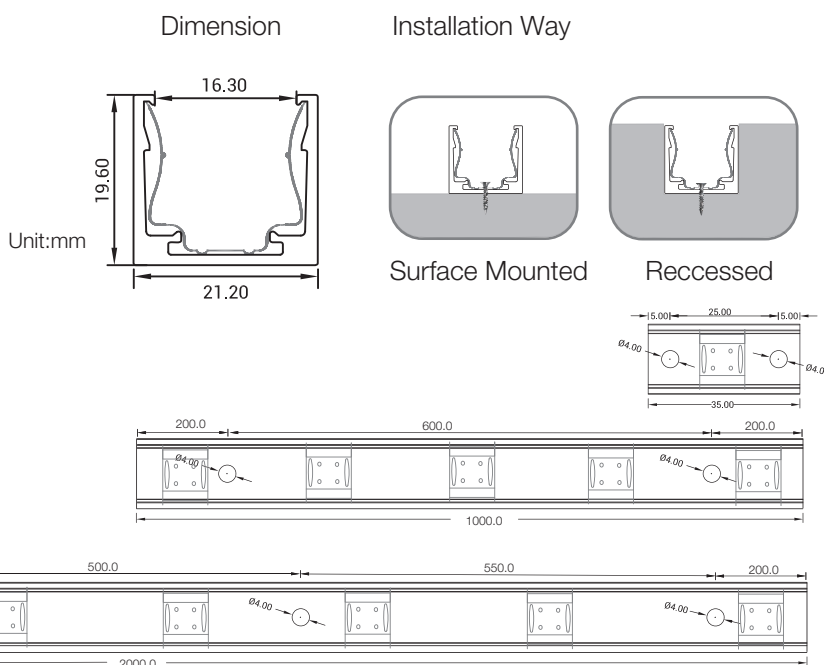
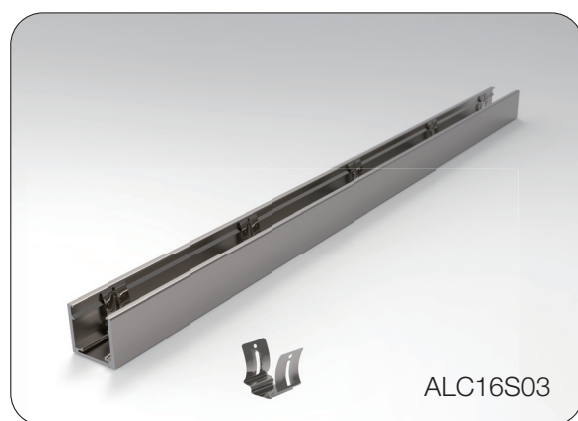

Model	W x H(mm)	Standard Length	Screw Holes	Holes Numbers	Clips	Suitable Product
ALC16S03	21.2*19.6	35mm	Φ4.0mm	2	1	T16, S17, SF16, SF17
		1000mm	Φ4.0mm	2	5	T16, S17, SF16, SF17
		2000mm	Φ4.0mm	4	8	T16, S17, SF16, SF17

# LED linear Flex Mounting Channel

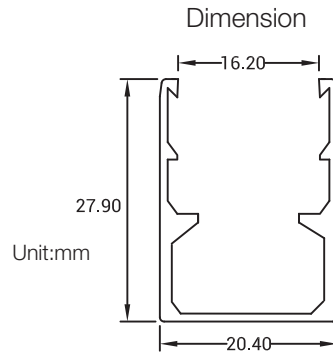
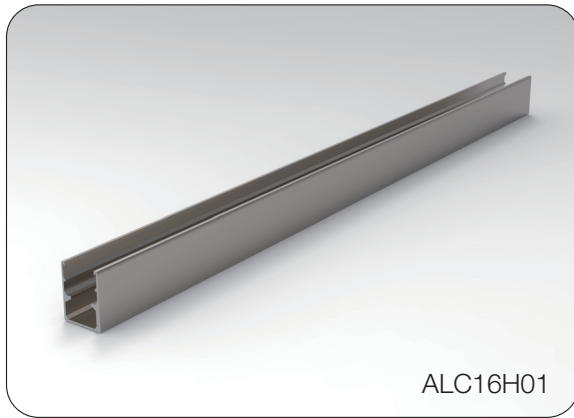

Installation Way

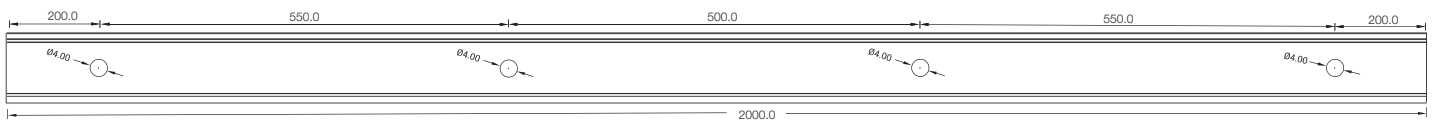
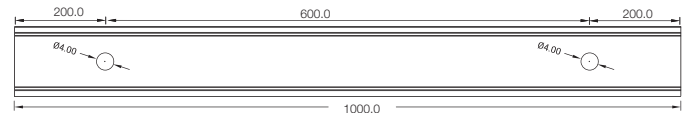
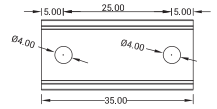
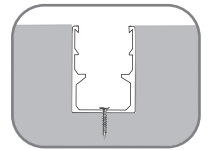
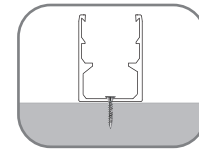

Model	W x H(mm)	Standard Length	Screw Holes	Holes Numbers	Suitable Product
ALC16H01	20.4*27.9	35mm	Φ4.0mm	2	T16, S17, SF16, SF17
		1000mm	Φ4.0mm	2	T16, S17, SF16, SF17
		2000mm	Φ4.0mm	4	T16, S17, SF16, SF17

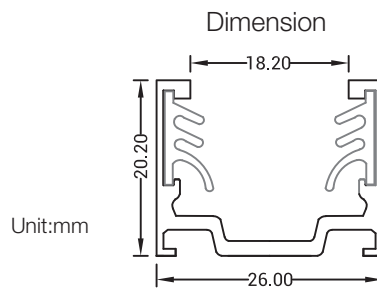
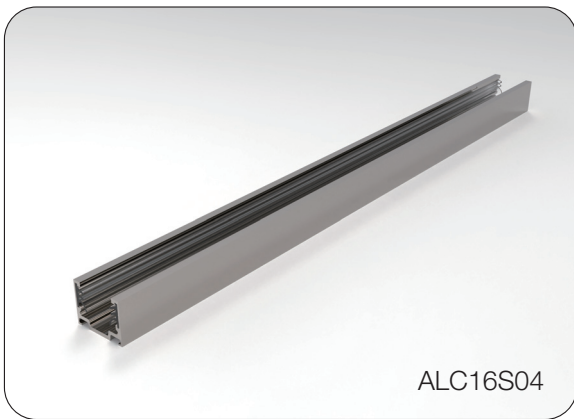

Installation Way

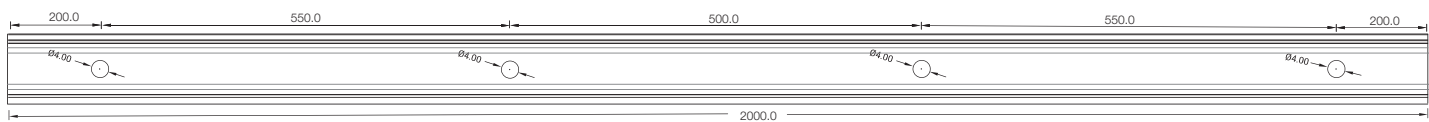
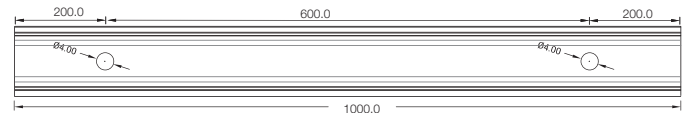
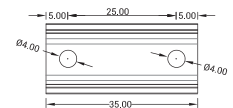
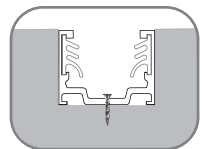
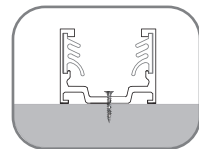

Model	W x H(mm)	Standard Length	Screw Holes	Holes Numbers	Clips	Suitable Product
ALC16S04	26.0*20.2	35mm	Φ4.0mm	2	2	T16, S17, SF16, SF17
		1000mm	Φ4.0mm	2	2	T16, S17, SF16, SF17
		2000mm	Φ4.0mm	4	2	T16, S17, SF16, SF17

# LED linear Flex Mounting Channel

## 2. Flexible Aluminum Channel

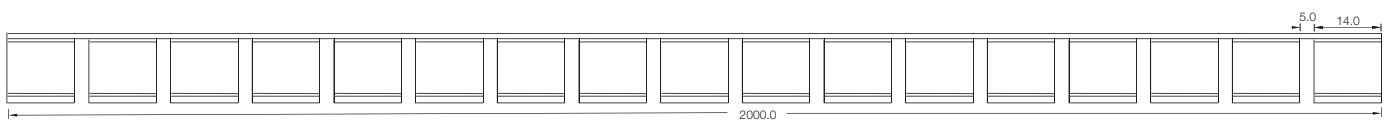
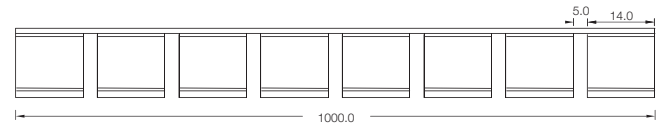
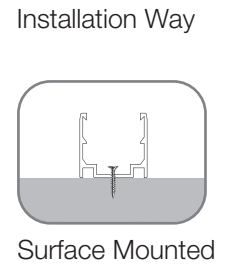
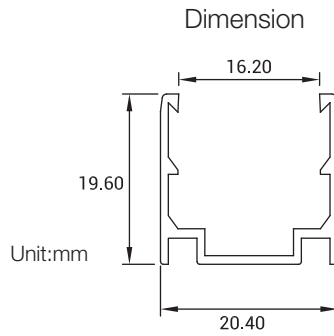
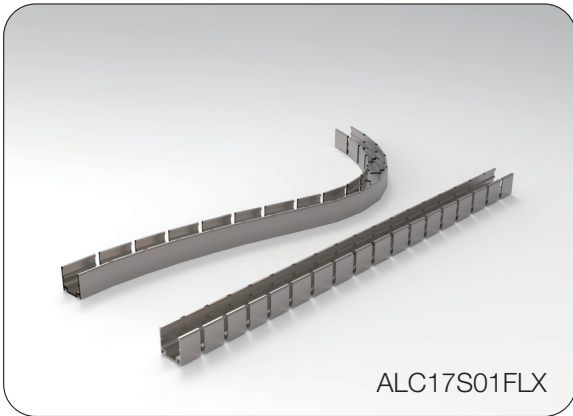

Model	W x H(mm)	Standard Length	Suitable Product
ALC17FLX	20.4*19.6	1000mm	S17, SF17
		2000mm	S17, SF17

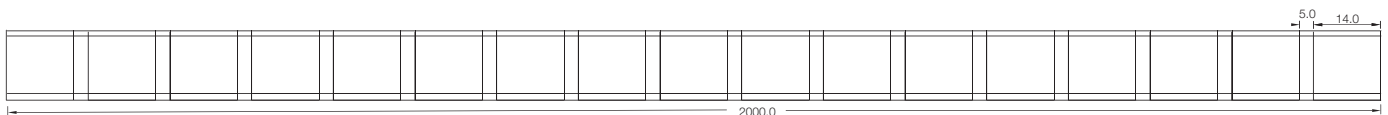
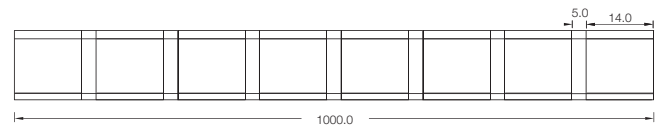
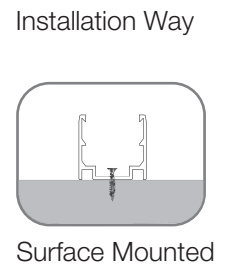
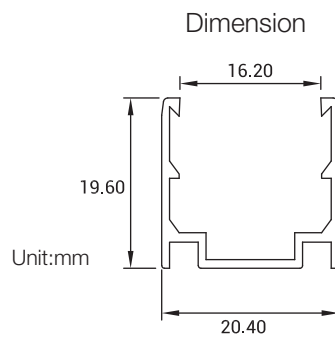
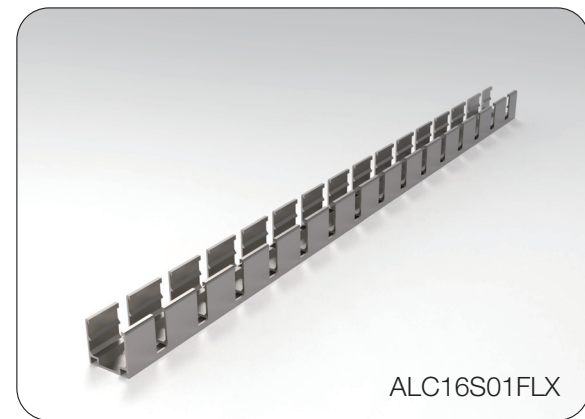

Model	W x H(mm)	Standard Length	Suitable Product
ALC16S01FLX	20.4*19.6	1000mm	T16, SF16
		2000mm	T16, SF16

# LED linear Flex Mounting Channel

## 3. Plastic Channel

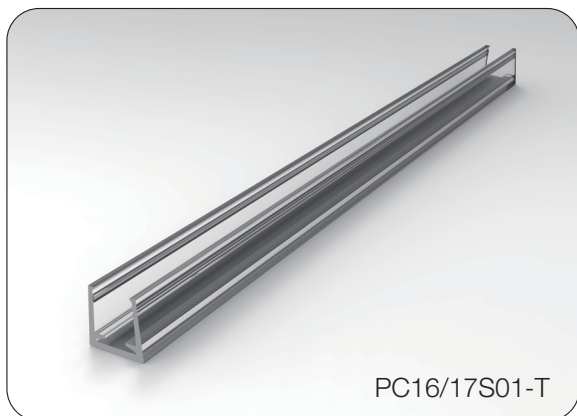

Dimension

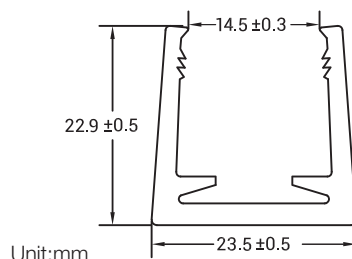

Installation Way

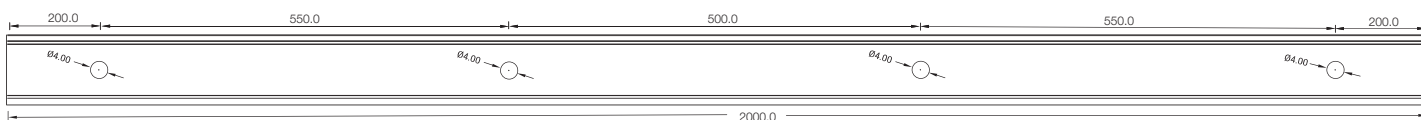
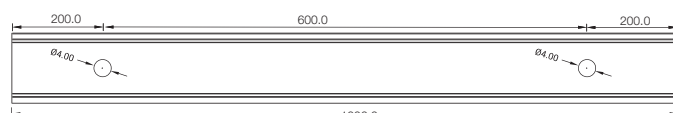
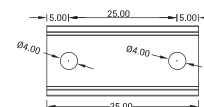
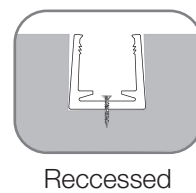
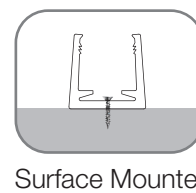

Model	W x H(mm)	Standard Length	Screw Holes	Holes Numbers	Suitable Product
PC16/17S01-T	24.6*22.9	1000mm	Φ4.0mm	2	T16, S17, SF16, SF17
		2000mm	Φ4.0mm	4	T16, S17, SF16, SF17

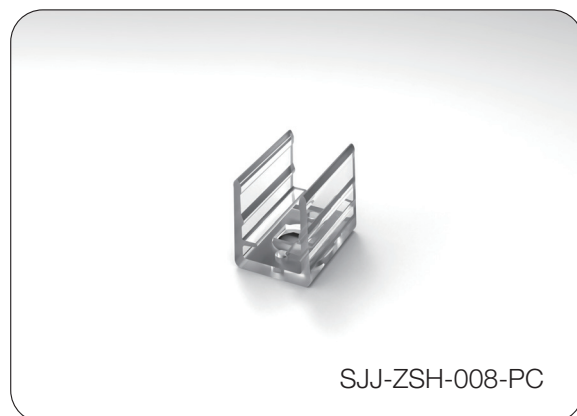

Dimension

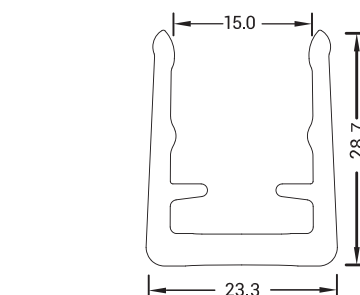

Installation Way

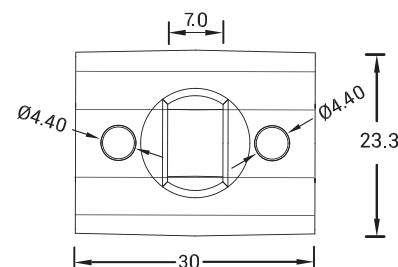
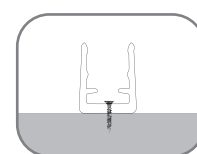

Model	W x H(mm)	Standard Length	Screw Holes	Holes Numbers	Suitable Product
SJJ-ZSH-008-PC	23.3*28.7	30mm	Φ4.40mm	2	T16, S17, T18, SF16, SF17, SF18

# LED linear Flex Mounting Channel

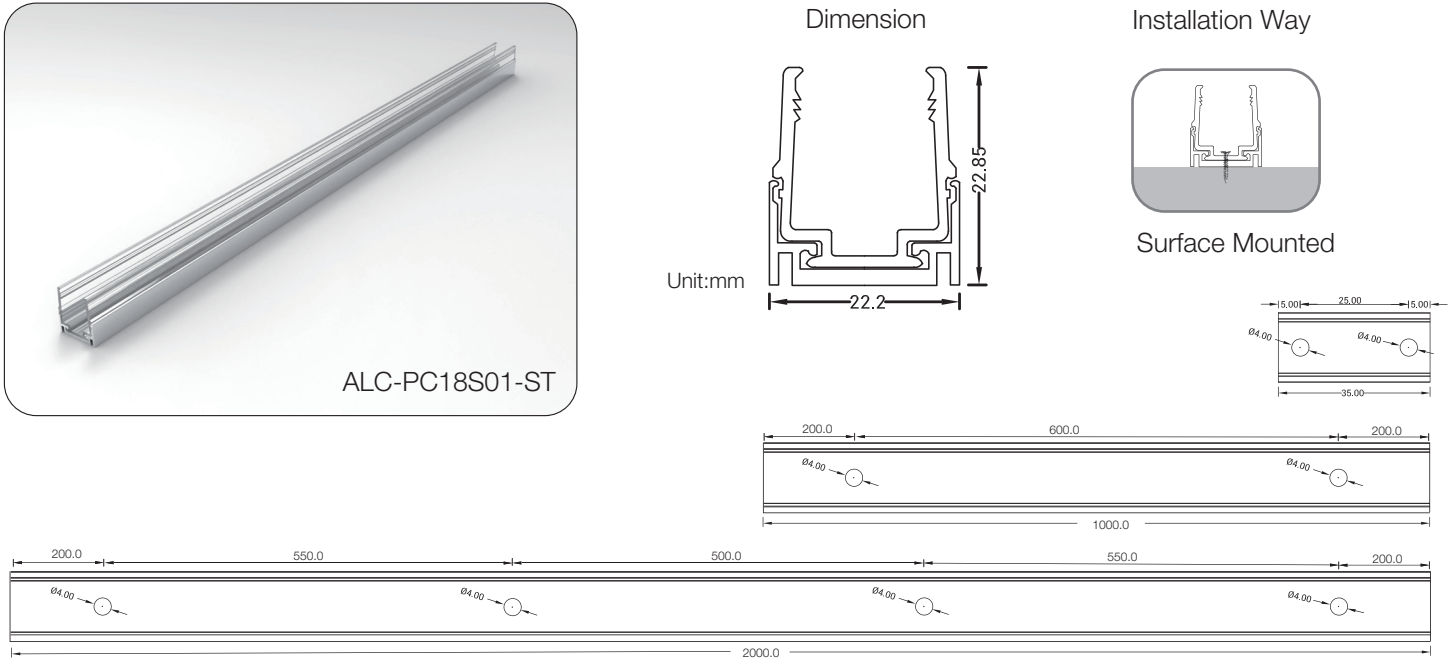
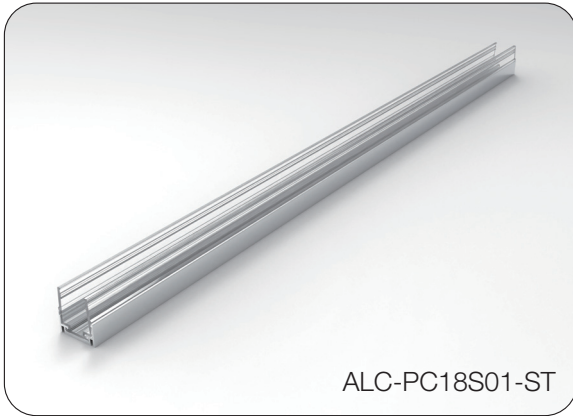

Model	W x H(mm)	Standard Length	Screw Holes	Holes Numbers	Suitable Product
ALC-PC18S01-ST	22.2*22.85	35mm	Φ4.0mm	2	T16, S17, T18, SF16, SF17, SF18
		1000mm	Φ4.0mm	2	T16, S17, T18, SF16, SF17, SF18
		2000mm	Φ4.0mm	4	T16, S17, T18, SF16, SF17, SF18

## 4. Stainless Steel Channel

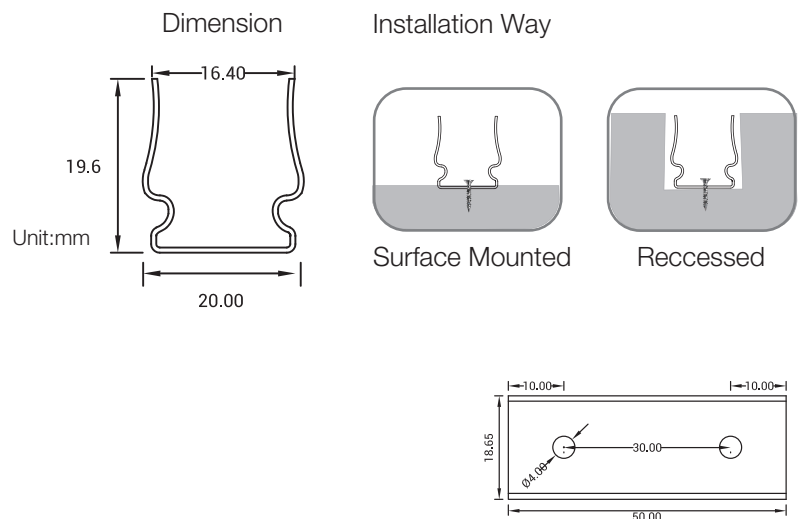
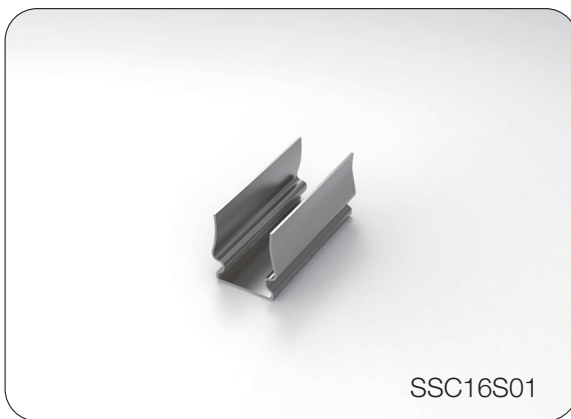

Model	W x H(mm)	Standard Length	Screw Holes	Holes Numbers	Suitable Product
SSC16S01	20.0*19.6	50mm	Φ4.0mm	2	T16, SF16, S17, SF17



# LED linear Flex Mounting Channel

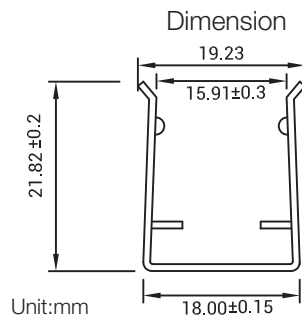
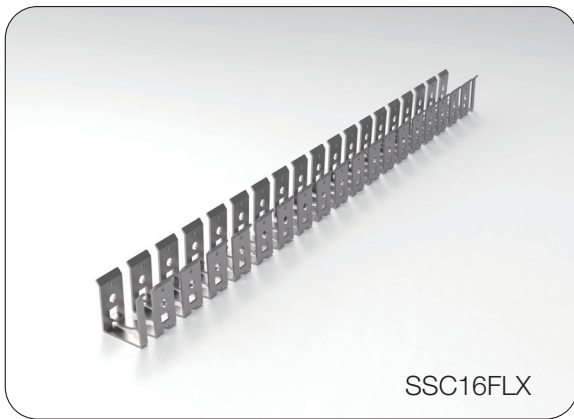

Installation Way

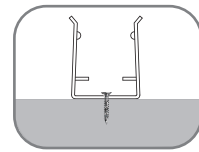

Surface Mounted

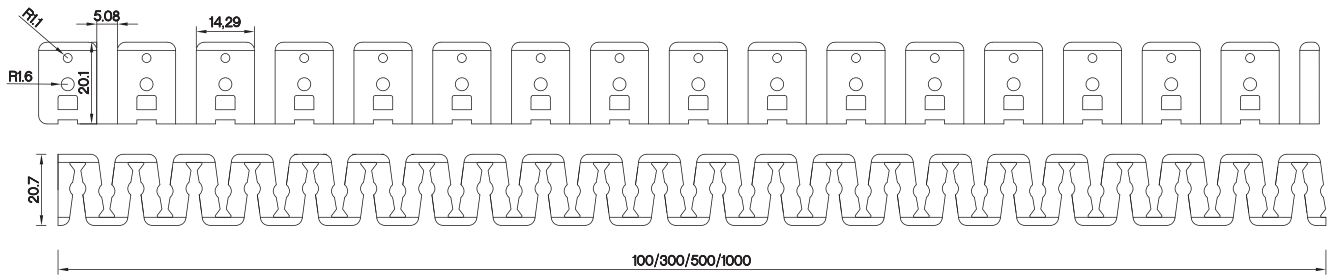

Model	W x H(mm)	Standard Length	Suitable Product
SSC16FLX	18.15*22.0	100mm	T16, S17, SF16, SF17
		300mm	T16, S17, SF16, SF17
		500mm	T16, S17, SF16, SF17
		500mm	T16, S17, SF16, SF17

# LED linear Flex Packing Details



Standard: Carton ( Paper Reel Inside)

Product	Max.Length	Carton Size	Net Weight	Gross Weight
S15/SF15	30m	34*34*18cm	12kg	13.6kg
T16/SF16	20m	34*34*18cm	8.6kg	10.2kg
T17/SF17	20m	34*34*18cm	8.6kg	10.2kg
T18/SF18	20m	34*34*18cm	8.6kg	10.2kg
S21/SF21	20m	34*34*18cm	10.4kg	12.0kg
T10/SF10	30m	34*34*18cm	9.6kg	11.2kg
S09/SF09	35m	34*34*18cm	5.8kg	7.4kg
T08/SF08	30m	34*34*18cm	7.2kg	8.8kg
T06/SF06	30m	34*34*18cm	7.2kg	8.8kg



Custom: Carton ( White Box+ Plastic Plate Inside)

Product	Package 1 Dimension	Length	Gross Weight	Package 2 Dimension	Length	Gross Weight
S15/SF15	38*38*3cm	5m	2.5kg	45*55*3cm	10m	5kg
T16/SF16	38*38*3cm	5m	2.6kg	51*61*4cm	10m	5.2kg
S17/SF17	38*38*3cm	5m	2.6kg	51*61*4cm	10m	5.2kg
T18/SF18	38*38*3cm	5m	2.6kg	51*61*4cm	10m	5.2kg
S21/SF21	38*38*3cm	5m	3.1kg	51*61*4cm	10m	6.2kg
T10/SF10	38*38*3cm	5m	2.0kg	45*55*3cm	10m	4kg
S09/SF09	38*38*3cm	5m	1.5kg	45*55*3cm	10m	3kg
T08/SF08	38*38*3cm	5m	1.5kg	45*55*3cm	10m	3kg
T06/SF06	38*38*3cm	5m	1.5kg	45*55*3cm	10m	3kg