

S15 Configuration and Accessories

Mold injection Connector (IP68 Factory Assembly Only)

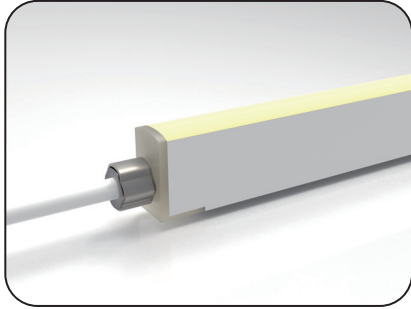

Direct Entry Connector
 MJ-15-A-D01/02/03
 MJ-15-A-D01SM
 MJ-15-A-D02SF
 MJ-15-A-D03SFM

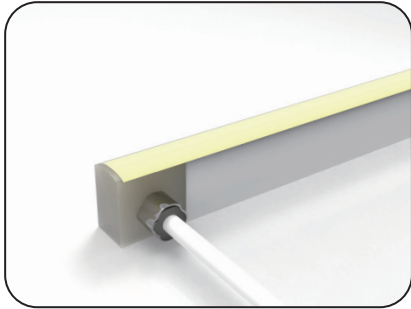
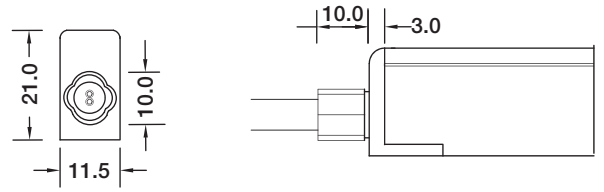

Side Entry Connector
 MJ-15-A-S01/02/03
 MJ-15-A-S01SM
 MJ-15-A-S02SF
 MJ-15-A-S03SFM

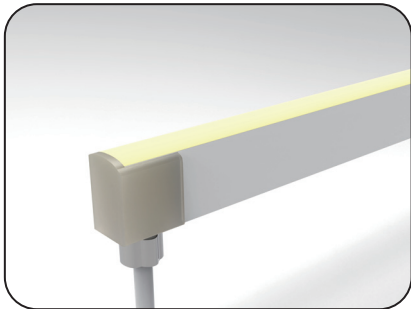
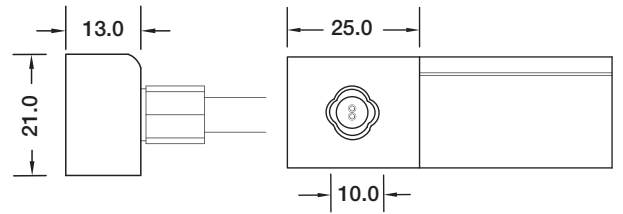

Bottom Entry Connector
 MJ-15-A-S01/02/03
 MJ-15-A-S01SM
 MJ-15-A-S02SF
 MJ-15-A-S03SFM

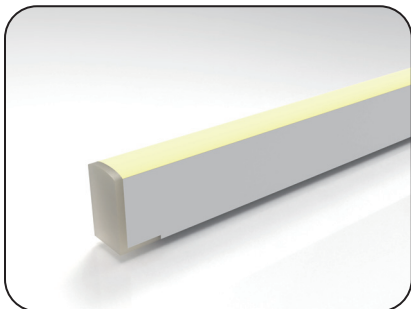
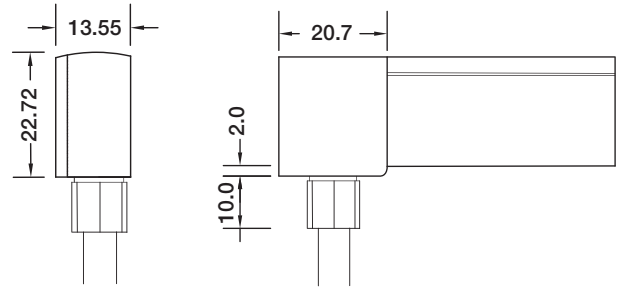

End Cap

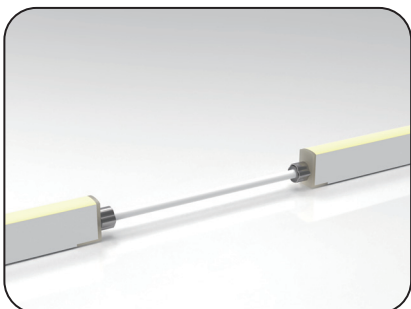
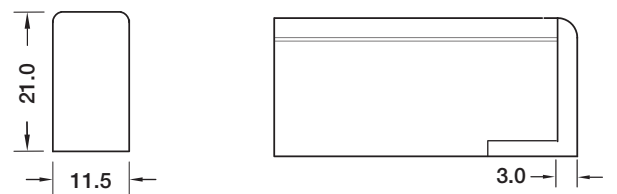

Jumper
 MJ-15-A-D-JC

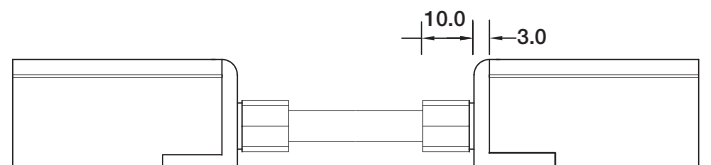

S15 Configuration and Accessories

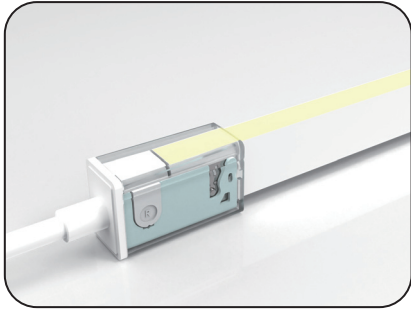

DIY Snap Connector
DIY-SN-FR-15-D-01/02-A

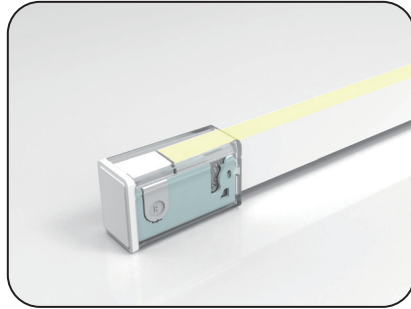
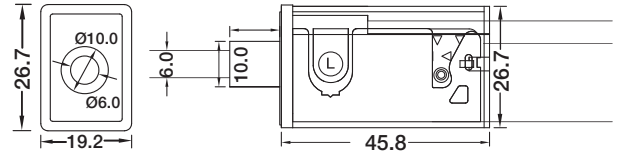

DIY Snap End Cap
DIY-SN-END-15-D-01/02

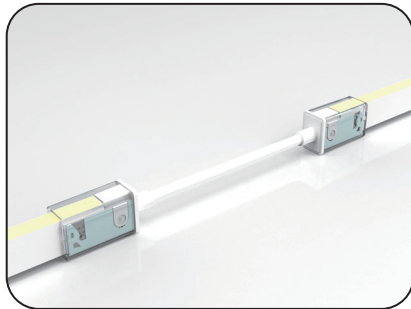
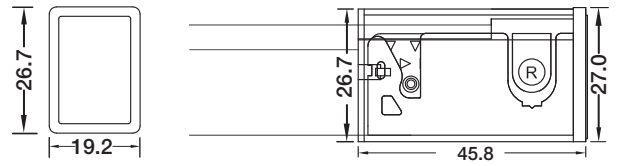

DIY Snap Connector Jumper
DIY-SN-FR-15-A-D-JC

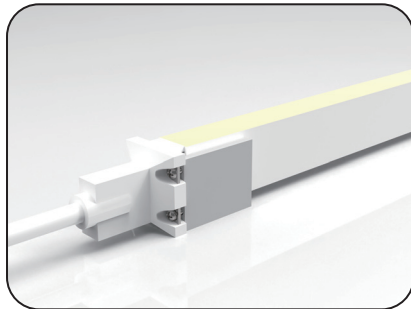
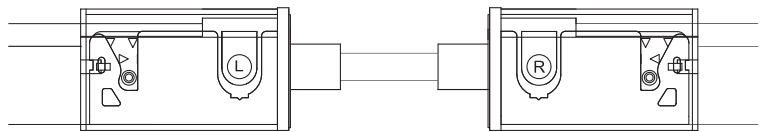

DIY Screw Connector
DIY-SC-FR-15-D-01/02-A

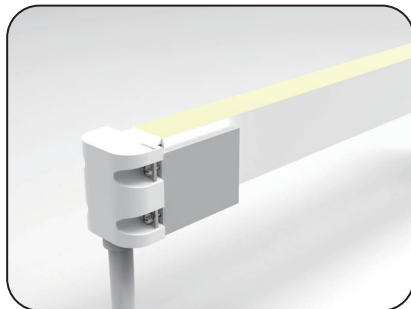
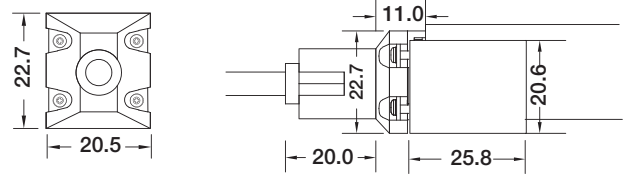

DIY Screw Connector
DIY-SC-FR-15-B-01/02-A

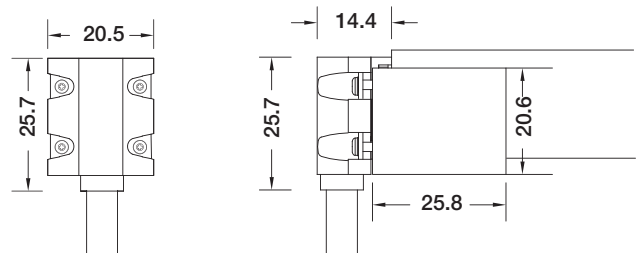

S15 Configuration and Accessories

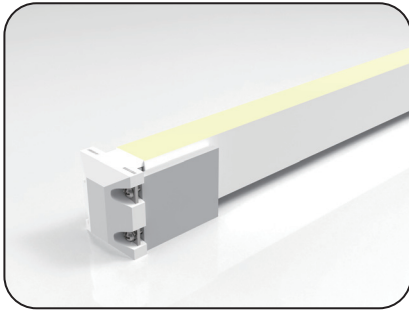

DIY Screw Connector
DIY-SC-END-15

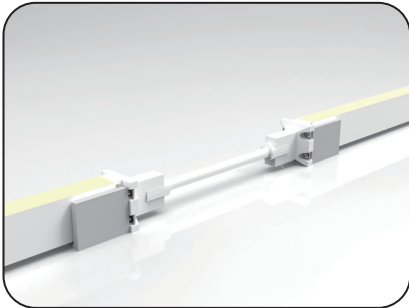
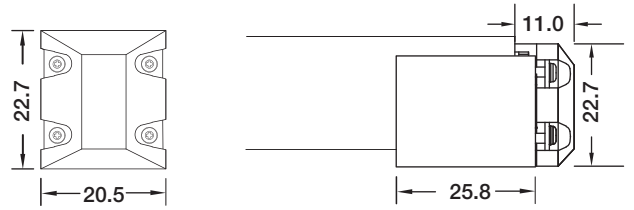

DIY Screw Extension Connector
DIY-SC-EXT-15-A

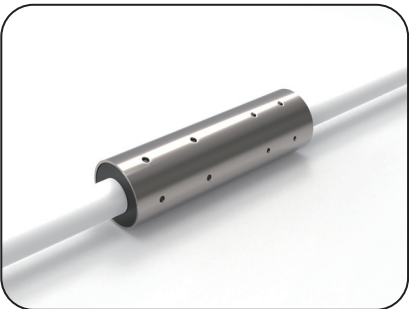
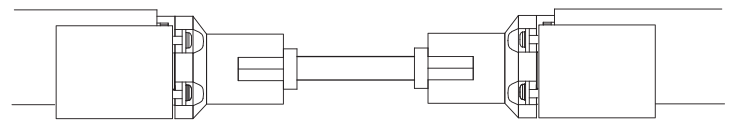

Waterproof Interrupter

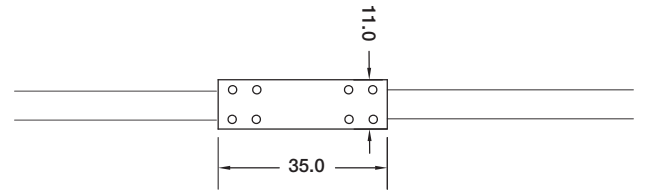

Male Connector
SYZ-M12-M-2C-075-W

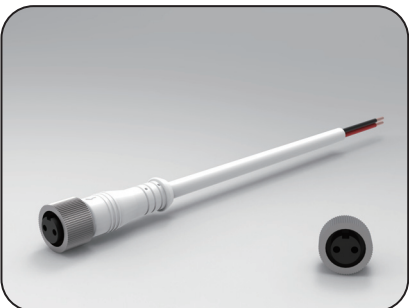
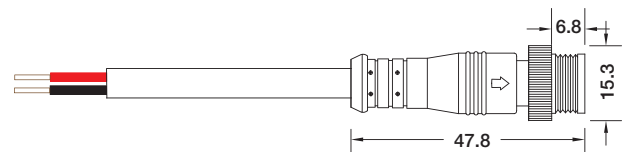

Female Connector
SYZ-M12-F-2C-075-W

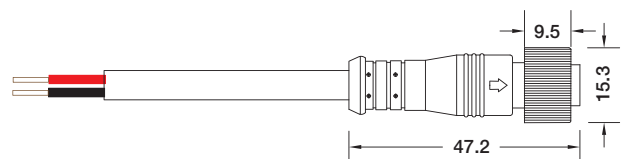

LED linear Flex Mounting Channel

1. Aluminum Channel

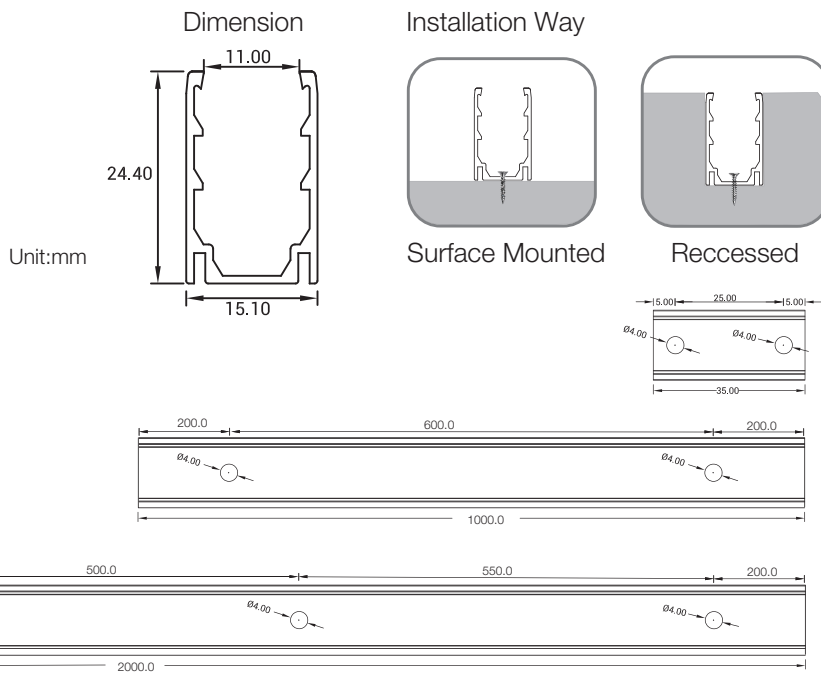
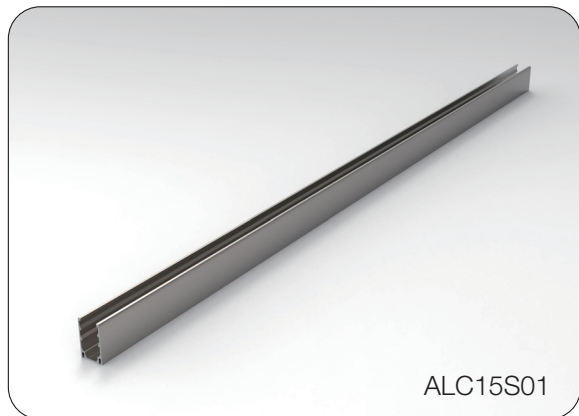

Model	W x H(mm)	Standard Length	Screw Holes	Holes Numbers	Suitable Product
ALC15S01	15.1*24.4	35mm	Φ4.0mm	2	S15, SF15
		1000mm	Φ4.0mm	2	S15, SF15
		2000mm	Φ4.0mm	4	S15, SF15

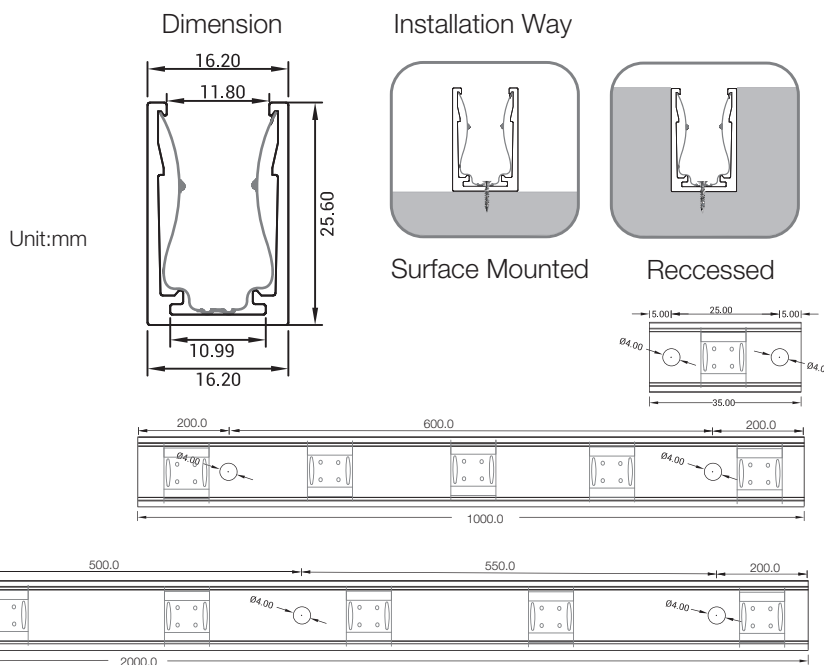
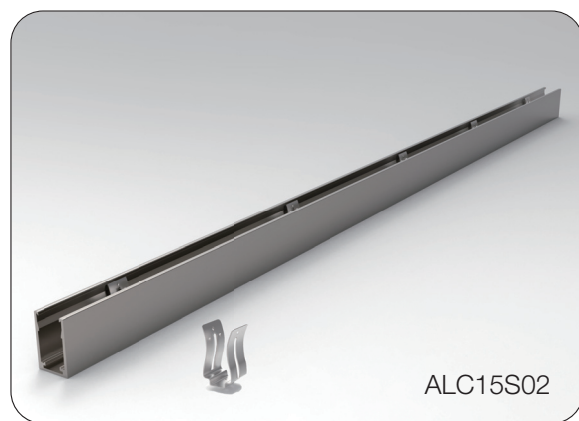

Model	W x H(mm)	Standard Length	Screw Holes	Holes Numbers	Clips	Suitable Product
ALC15S02	21.2*19.6	35mm	Φ4.0mm	2	1	S15, S21, SF15, SF21
		1000mm	Φ4.0mm	2	5	S15, S21, SF15, SF21
		2000mm	Φ4.0mm	4	8	S15, S21, SF15, SF21

LED linear Flex Mounting Channel

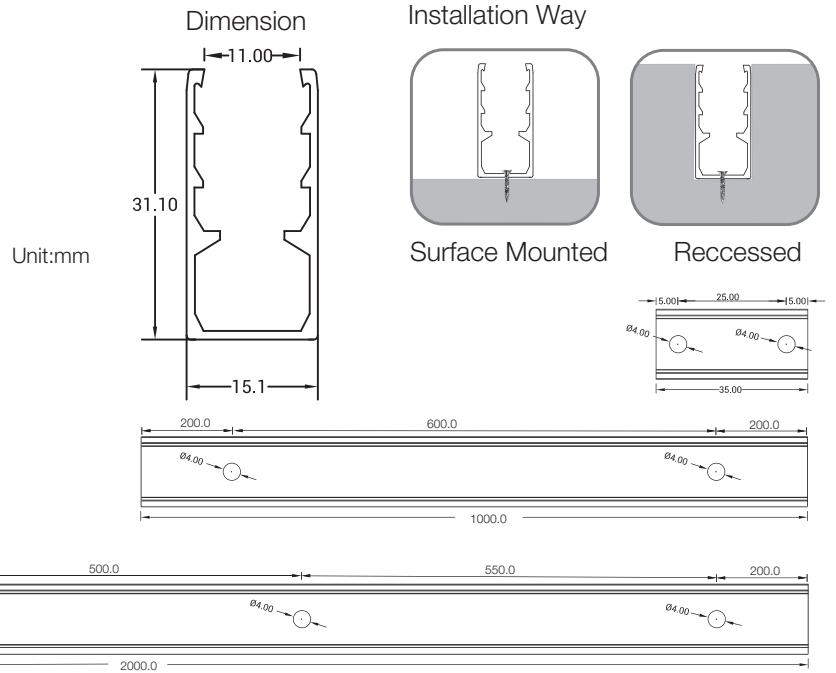
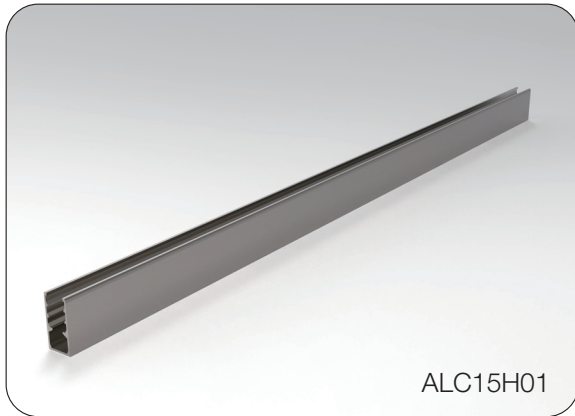

Model	W x H(mm)	Standard Length	Screw Holes	Holes Numbers	Suitable Product
ALC15H01	15.1*31.1	35mm	Φ4.0mm	2	S15, S21, SF15, SF21
		1000mm	Φ4.0mm	2	S15, S21, SF15, SF21
		2000mm	Φ4.0mm	4	S15, S21, SF15, SF21

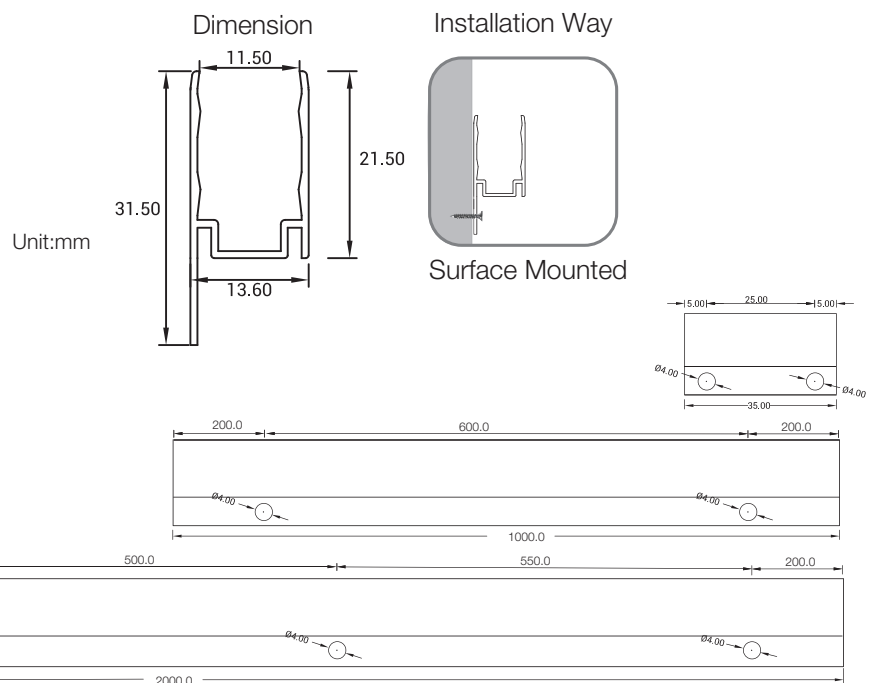
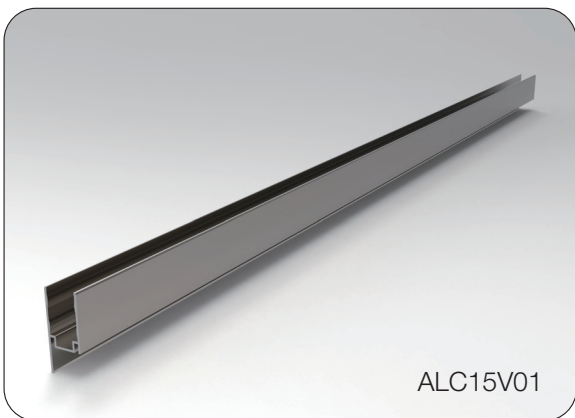

Model	W x H(mm)	Standard Length	Screw Holes	Holes Numbers	Suitable Product
ALC15V01	13.6*31.5	35mm	Φ4.0mm	2	S15, S21, SF15, SF21
		1000mm	Φ4.0mm	2	S15, S21, SF15, SF21
		2000mm	Φ4.0mm	4	S15, S21, SF15, SF21

LED linear Flex Mounting Channel

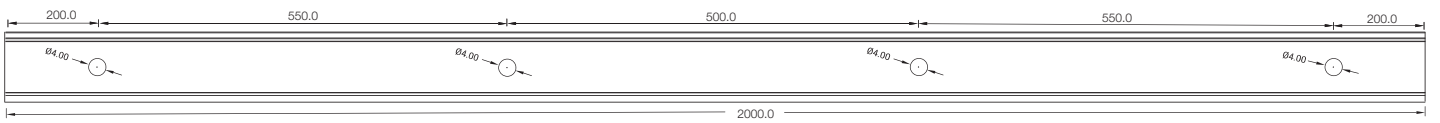
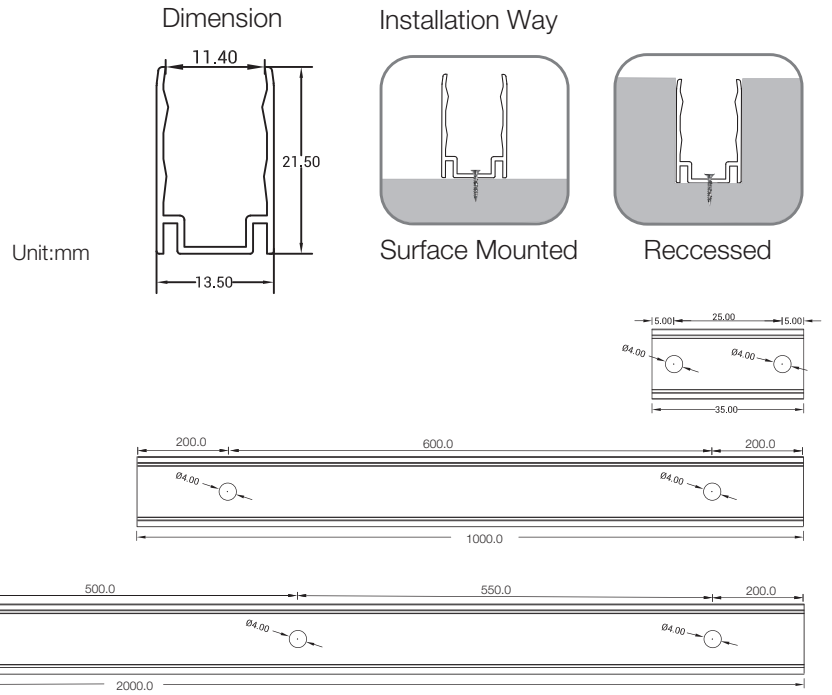
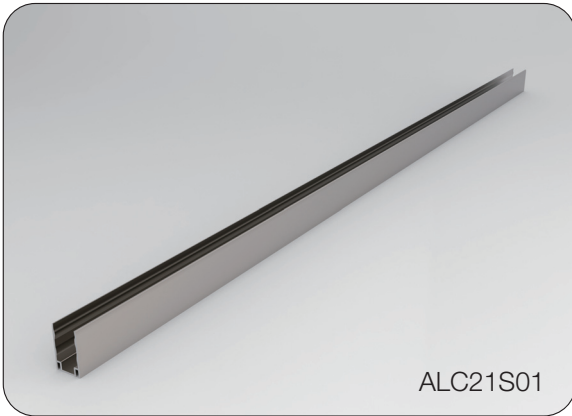

Model	W x H(mm)	Standard Length	Screw Holes	Holes Numbers	Suitable Product
ALC21S01	13.5*21.5	35mm	Ø4.0mm	2	S21, SF21
		1000mm	Ø4.0mm	2	S21, SF21
		2000mm	Ø4.0mm	4	S21, SF21

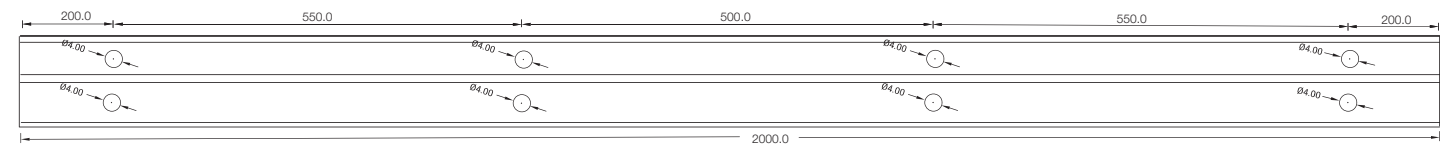
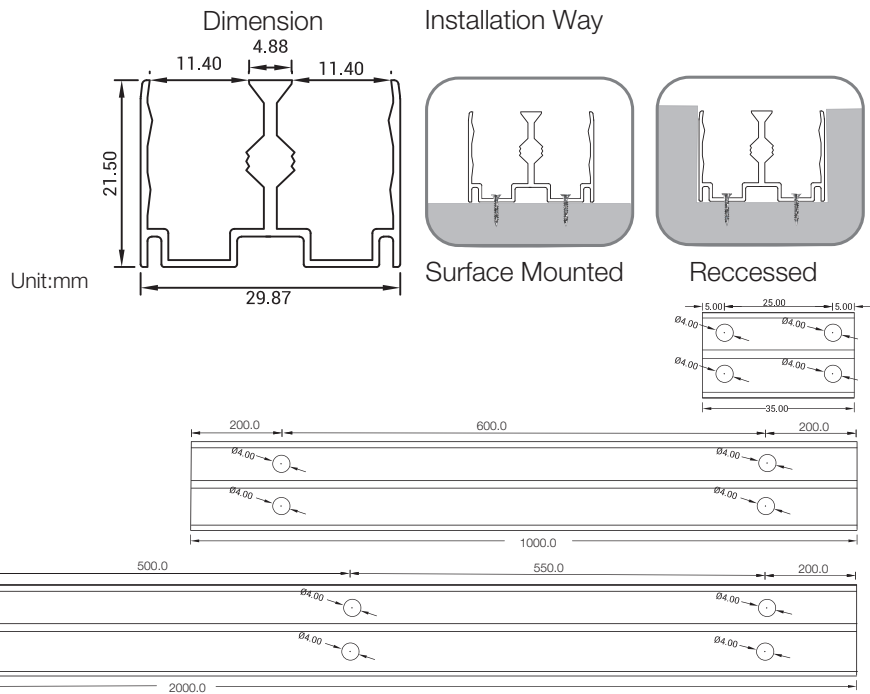
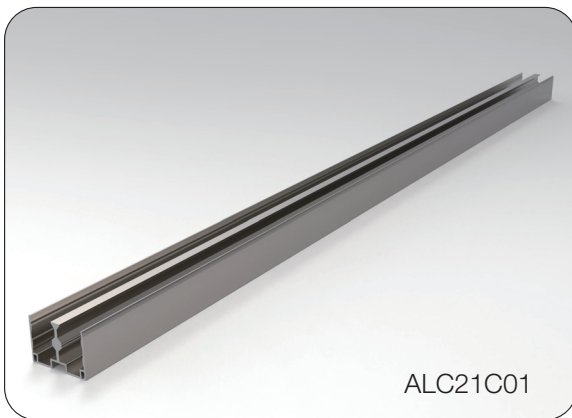

Model	W x H(mm)	Standard Length	Screw Holes	Holes Numbers	Suitable Product
ALC21S01	29.87*21.5	35mm	Ø4.0mm	4	S21, SF21
		1000mm	Ø4.0mm	4	S21, SF21
		2000mm	Ø4.0mm	8	S21, SF21

LED linear Flex Mounting Channel

2. Flexible Aluminum Channel

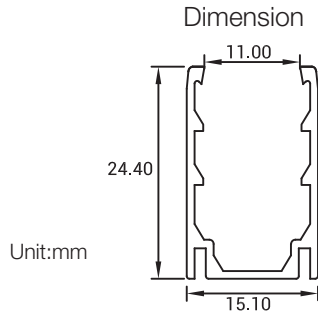
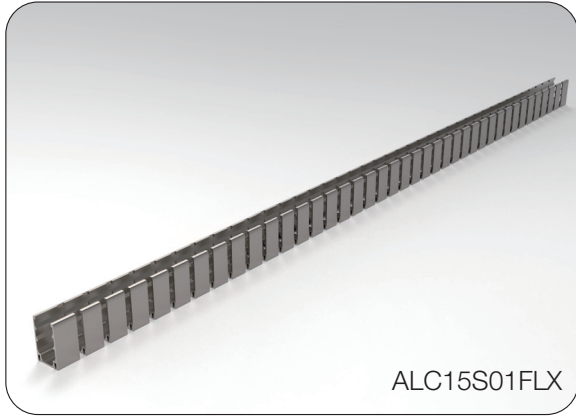

Installation Way

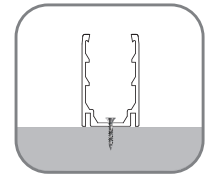

Surface Mounted

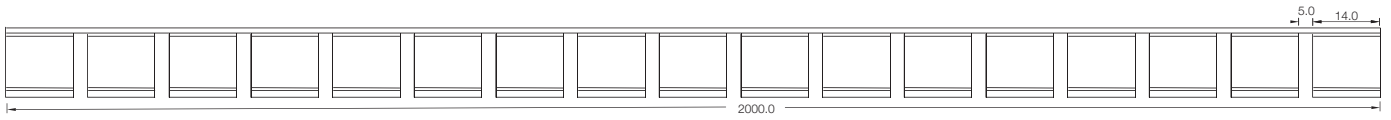
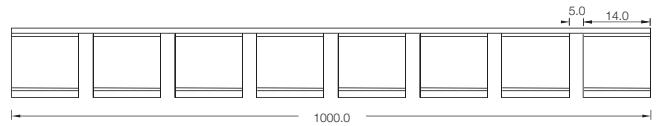

Model	W x H(mm)	Standard Length	Screw Holes	Holes Numbers	Suitable Product
ALC15S01FLX	15.1*24.4	1000mm	Φ4.0mm	2	S15, SF15
		2000mm	Φ4.0mm	4	S15, SF15

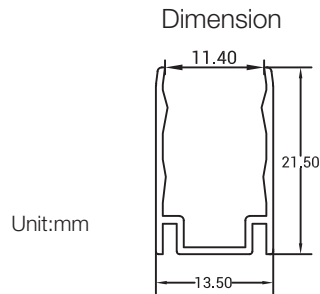
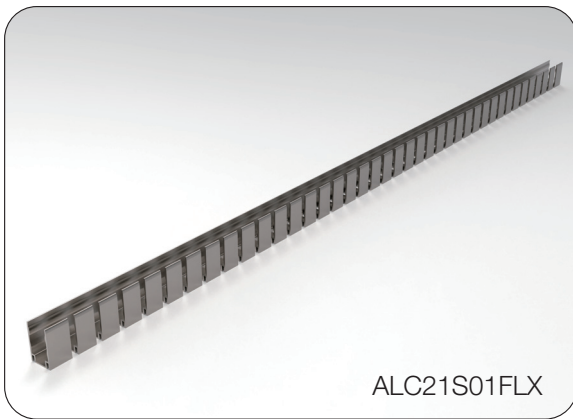

Installation Way

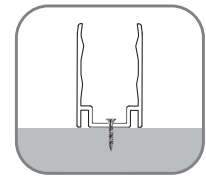

Surface Mounted

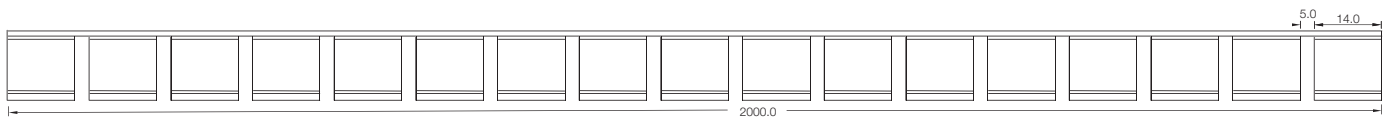
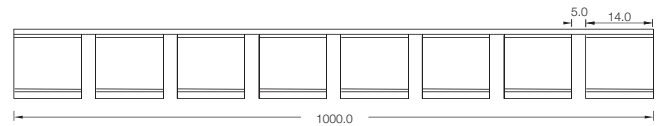

Model	W x H(mm)	Standard Length	Suitable Product
ALC21S01FLX	13.5*21.5	1000mm	S21, SF21
		2000mm	S21, SF21

LED linear Flex Mounting Channel

3. Plastic Channel

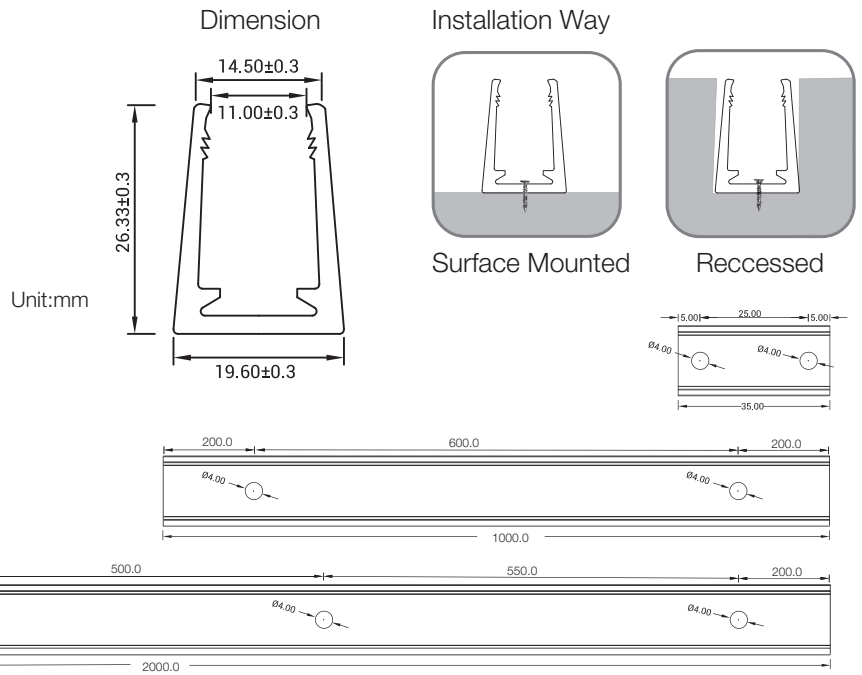
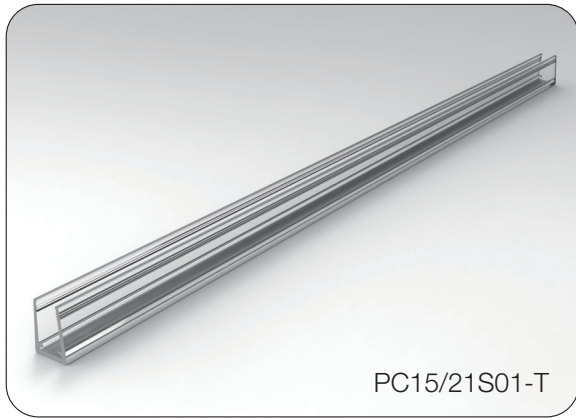

Model	W x H(mm)	Standard Length	Screw Holes	Holes Numbers	Suitable Product
PC15/21S01-T	19.6*26.3	35mm	Ø4.0mm	2	S15, S21, SF15, SF21
		1000mm	Ø4.0mm	2	S15, S21, SF15, SF21
		2000mm	Ø4.0mm	4	S15, S21, SF15, SF21

4. Stainless steel Channel

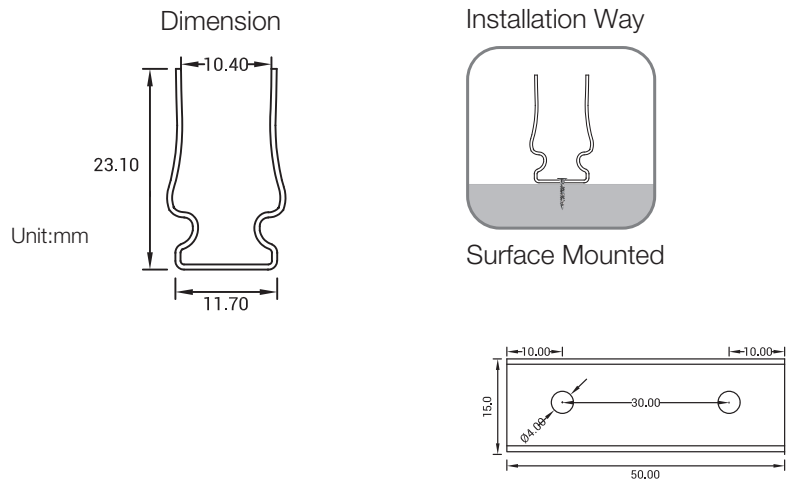
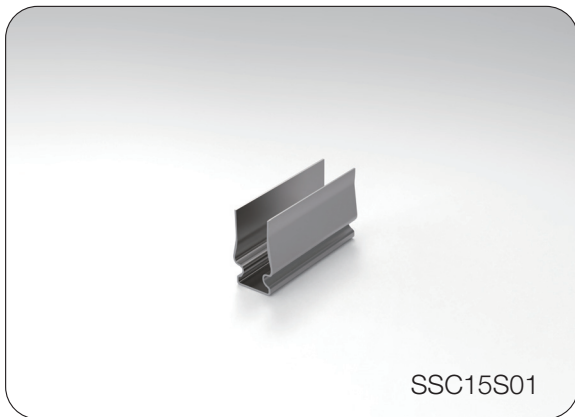

Model	W x H(mm)	Standard Length	Screw Holes	Holes Numbers	Suitable Product
SSC15S01	11.7*23.1	50mm	Ø4.0mm	2	S15, S21, SF15, SF21

LED linear Flex Mounting Channel

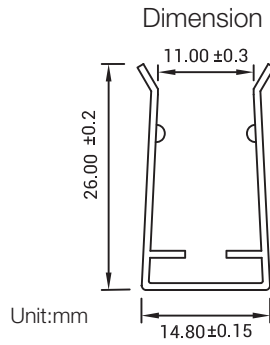
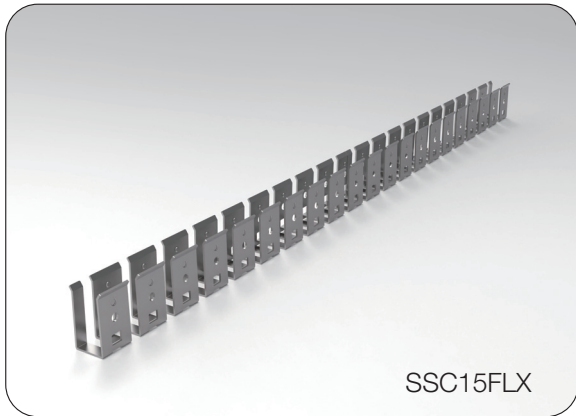

Installation Way

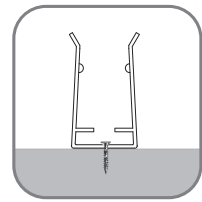

Surface Mounted

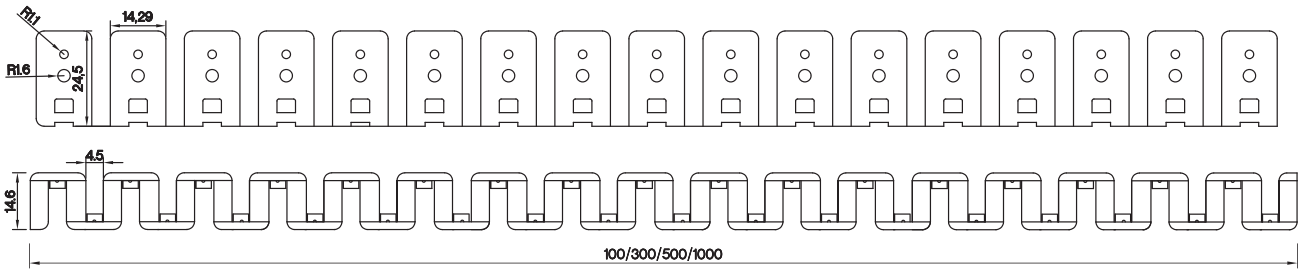

Model	W x H(mm)	Standard Length	Suitable Product
SSC15 FLX	14.8*26.0	100mm	S15, S21, SF15, SF21
		300mm	S15, S21, SF15, SF21
		500mm	S15, S21, SF15, SF21
		500mm	S15, S21, SF15, SF21

LED linear Flex Packing Details

Standard: Carton (Paper Reel Inside)



Product	Max.Length	Carton Size	Net Weight	Gross Weight
S15/SF15	30m	34*34*18cm	12kg	13.6kg
T16/SF16	20m	34*34*18cm	8.6kg	10.2kg
S17/SF17	20m	34*34*18cm	8.6kg	10.2kg
T18/SF18	20m	34*34*18cm	8.6kg	10.2kg
S21/SF21	20m	34*34*18cm	10.4kg	12.0kg
T10/SF10	30m	34*34*18cm	9.6kg	11.2kg
S09/SF09	35m	34*34*18cm	5.8kg	7.4kg
S08/SF08	30m	34*34*18cm	7.2kg	8.8kg
S06/SF06	30m	34*34*18cm	7.2kg	8.8kg

Custom: Carton (White Box+ Plastic Plate Inside)



Product	Package 1 Dimension	Length	Gross Weight	Package 2 Dimension	Length	Gross Weight
S15/SF15	38*38*3cm	5m	2.5kg	45*55*3cm	10m	5kg
S16/SF16	38*38*3cm	5m	2.6kg	51*61*4cm	10m	5.2kg
S17/SF17	38*38*3cm	5m	2.6kg	51*61*4cm	10m	5.2kg
T18/SF18	38*38*3cm	5m	2.6kg	51*61*4cm	10m	5.2kg
S21/SF21	38*38*3cm	5m	3.1kg	51*61*4cm	10m	6.2kg
T10/SF10	38*38*3cm	5m	2.0kg	45*55*3cm	10m	4kg
S09/SF09	38*38*3cm	5m	1.5kg	45*55*3cm	10m	3kg
S08/SF08	38*38*3cm	5m	1.5kg	45*55*3cm	10m	3kg
S06/SF06	38*38*3cm	5m	1.5kg	45*55*3cm	10m	3kg