

LED Intelligent Driver (constant voltage)

- Dimming interface: DMX512/RDM, Push DIM
- Dimming range from 0-100%, LED start at 0.1% possible.
- With soft-on and fade in function, visual more comfortable.
- Supports RDM remote device management protocol.
- 0-100% flicker-free, High frequency exemption level.
- High efficient driver: efficiency 93%, PF>0.98, THD<6%.
- In line with the EU energy efficiency ERP directive, standby power consumption < 0.5W
- Innovative thermal management technology, intelligent power life protection.
- Over-heat / Over voltage / Over load / Short circuit protection, recover automatically.
- Fully-protected plastic housing with design of dismantlable end cover.
- Suitable for internal lights application for I /II/III
- Up to 50000-hour life time
- 5 years warranty (Rubycon capacitor).

Flicker-free

IEEE 1789
Achieve the exemption level.

Dimmable:
0.1%-100%



SELV
RoHS

Class 2



(The certification icon represents undergoing certification applications only, and final certification qualification subject to actual product.)



Specification

Model	LM-150-12-G1M2	LM-150-24-G1M2	
OUTPUT	Output Voltage	12Vdc	24Vdc
	Output Voltage Range	12Vdc ±0.5Vdc	24Vdc ± 0.5Vdc
	Output Current	Max. 12.5A	Max. 6.25A
	Output Power	Max. 150W	
	Output Power Range	0-150W	
	Strobe Level	High frequency exemption level.	
	PWM Frequency	3600Hz	
	Dimming Range	0-100%, dimming depth: Max. 0.1%	
	Overload Power Limitation	≥ 102%	
	Ripple & Noise	Switch ripple ≤ 200mV, noise ≤ 800mV	Switch ripple ≤ 200mV, noise ≤ 500mV
INPUT	Dimming Interface	DMX/RDM, Push DIM	
	Input Voltage	220-240Vac 200-280Vdc	
	Frequency	50/60Hz	
	Input Current	Max. 0.75A/230Vac	
	Power Factor	PF>0.98/230Vac, at full load	
	THD	<6% at 230Vac, at full load	
	Efficiency (typ.)	92%	93%
	Standby Power Loss	< 0.5W	
	Inrush Current(typ.)	Cold start 45A at 230Vac	
	Control surge capability	L-N:2KV	
Leakage Current	Max. 0.5mA		
ENVIRONMENT	Working Temperature	ta: -20°C ~ 50°C tc: 85°C	
	Working Humidity	20 ~ 95%RH, non-condensing	
	Storage Temp., Humidity	-40°C ~ 80°C, 10-95%RH	
	Temp. Coefficient	±0.03%/°C (0-50°C)	
	Vibration	10-500Hz, 2G 12min./1cycle, period for 72min. each along X, Y, Z axes.	
PROTECTION	Over-heat Protection	Intelligently adjusting or turning off the output current if the PCB temperature ≥ 110°C, auto recovers.	
	Over Voltage Protection	Shut down the output when non-load voltage ≥ 16V, re-power on to recover after fault condition is removed.	Shut down the output when non-load voltage ≥ 28V, re-power on to recover after fault condition is removed.
	Over Load Protection	Shut down the output when current load ≥ 102%, auto recovers.	
	Short Circuit Protection	Enter hiccup mode if short circuit occurs, auto recovers.	
SAFETY & EMC	Withstand Voltage	I/P-O/P: 3750Vac	
	Isolation Resistance	I/P-O/P: 100MΩ/500VDC/25°C/70%RH	
	Safety Standards	IEC/EN61347-1, IEC/EN61347-2-13	
	EMC Emission	EN55015, EN61000-3-2 Class C, IEC61000-3-3	
	EMC Immunity	EN61000-4-2,3,4,5,6,8,11 EN61547	
	Strobe Test Standard	IEEE 1789	
OTHERS	Dimension	352×43×30mm(L×W×H)	
	Packing	355×44×33mm(L×W×H)	
	Weight[G.W.]	430g±10g	

* The driver is suitable for connecting resistor current-limiting LED fixture (e.g. LED strip). The inrush current will be dozens of times increased if connecting built-in constant current IC current-limiting LED fixtures, the driver will activate the overloaded protection (hiccup flickering). When you order, please remark controlling the constant current LED fixture (e.g. MR16 lamp, underground light, LED wall washer, constant current LED strip, etc.), then we can prepare the special programs.

Dimensions

Unit: mm

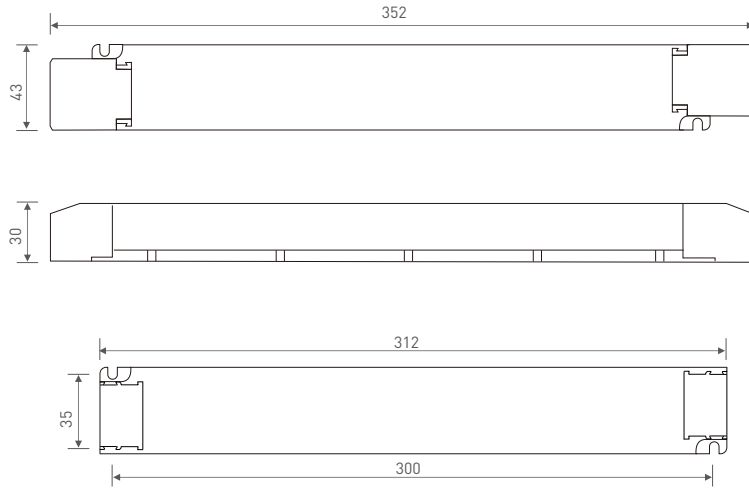

Wiring Diagram

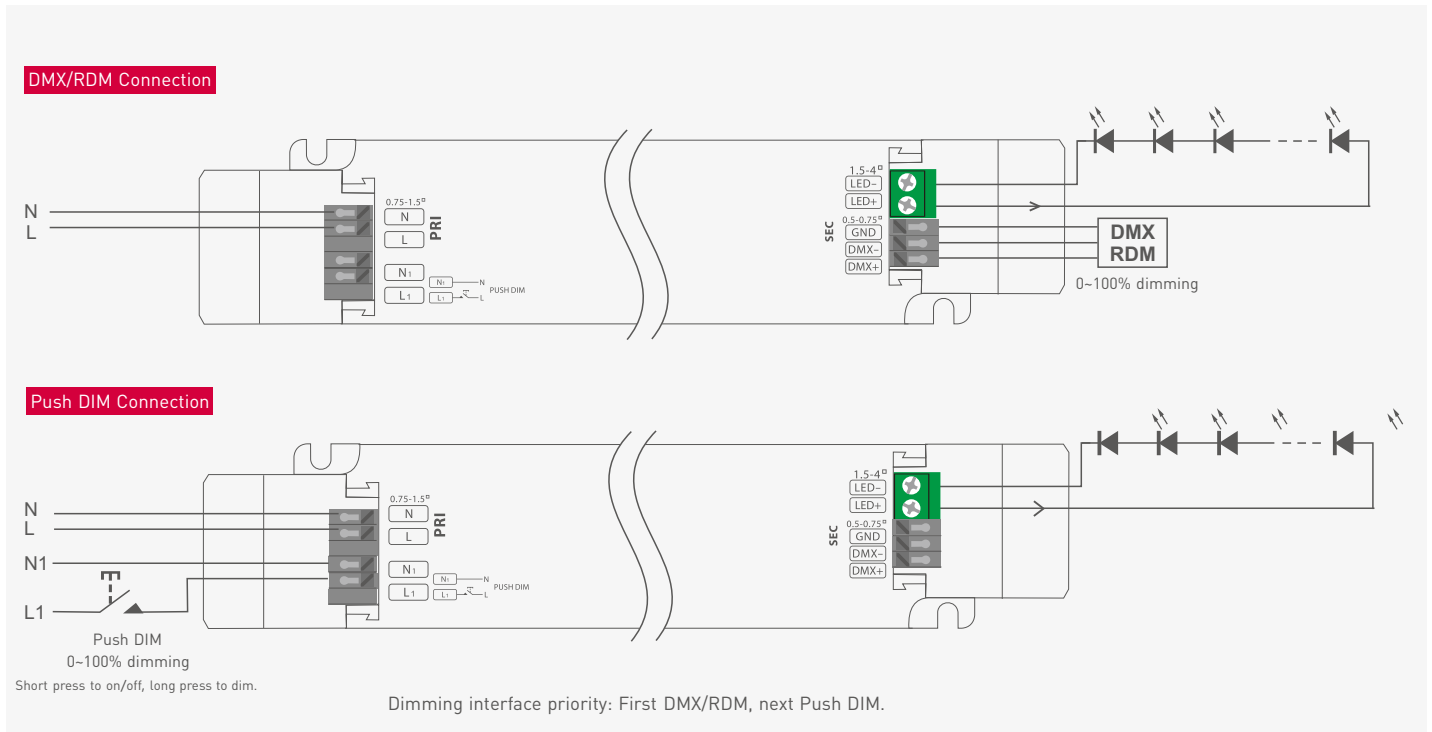

Push Dimming



Reset switch

- On/off control: Short press.
- Stepless dimming: Long press.
- With every other long press, the brightness goes to the opposite direction.
- Dimming memory: Brightness will be the same as previously adjusted when turning on again.

Application of Protective Cover

Wire pressing board:

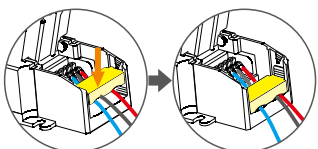

Push the wire pressing board to fix the wire.

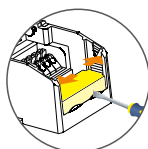

Push outward the side plate, meanwhile use the tool to uninstall the wire pressing board.

Uninstall protective cover:

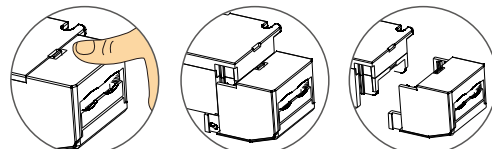

Break off the bottom left and right to remove the protective cover.

DMX Address Setting

The DMX driver can work with the address editor that complies with standard RDM protocol.

It is recommended to use LTECH's RDM editor (model WiFi-RDM01), which can achieve more functions such as remote browsing and parameter setting. Wiring diagram as below:

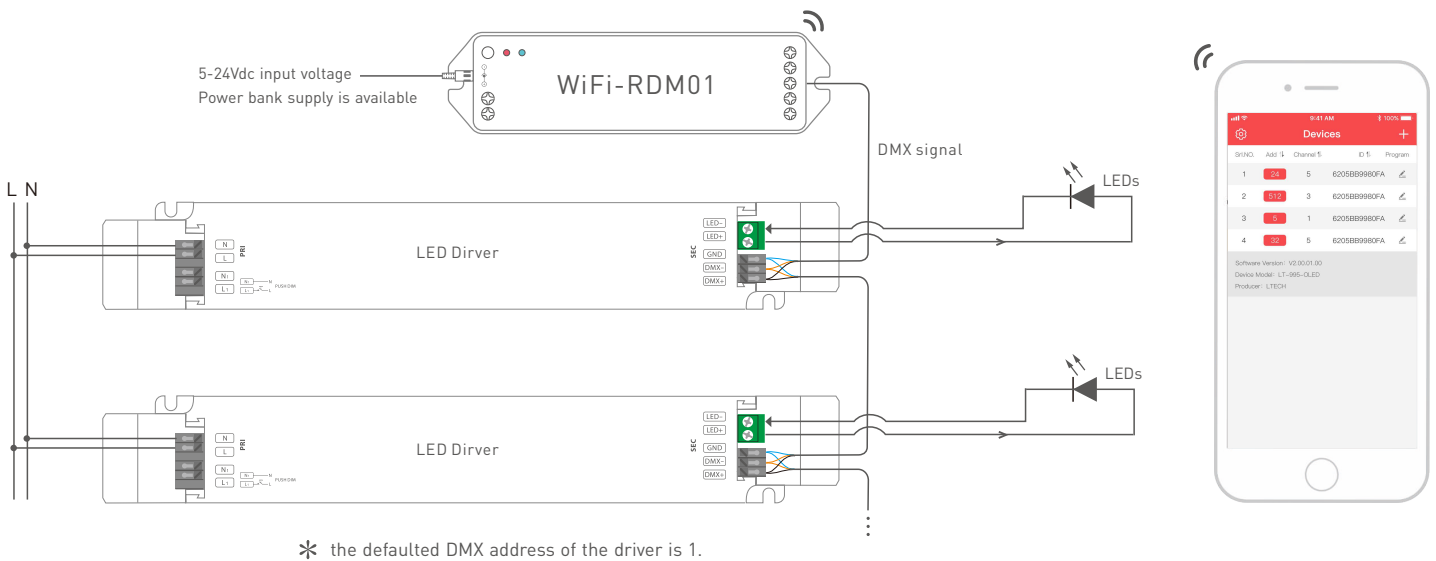

LTECH RDM editor App interface instruction

Download the App, setting the parameters after well connecting the RDM editor, please check the manual of WiFi-RDM01 for more details.

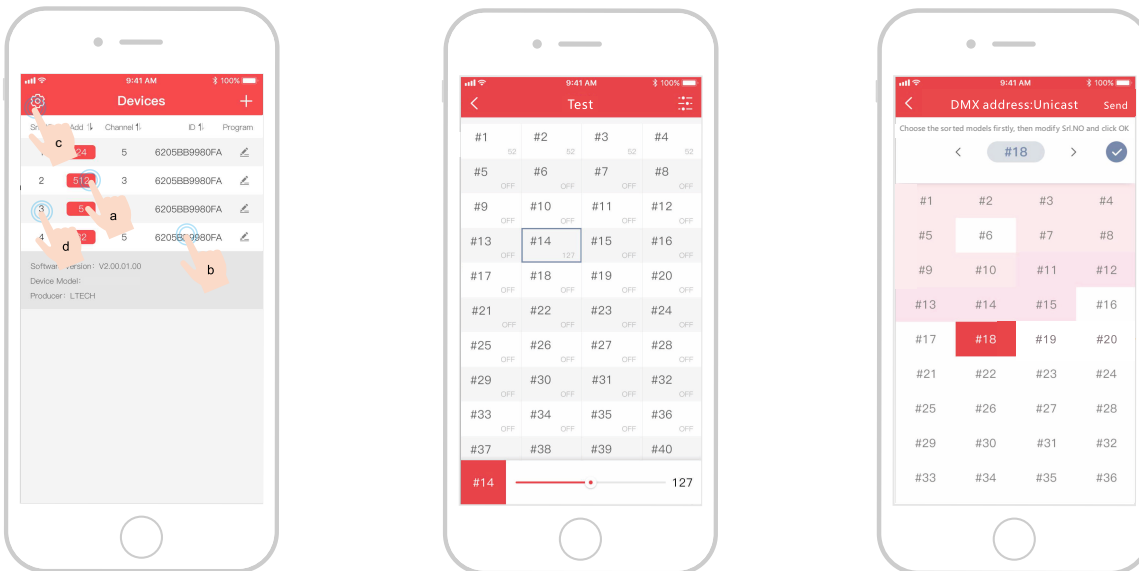

- a: Click "Add", edited the address in corresponding box.
- b: Click "ID", get more product details.
- c: Click "Settings", enter setting interface.
- d: Click "No.", issue the recognizing command.

Test

DMX address setting

Relationship Diagrams

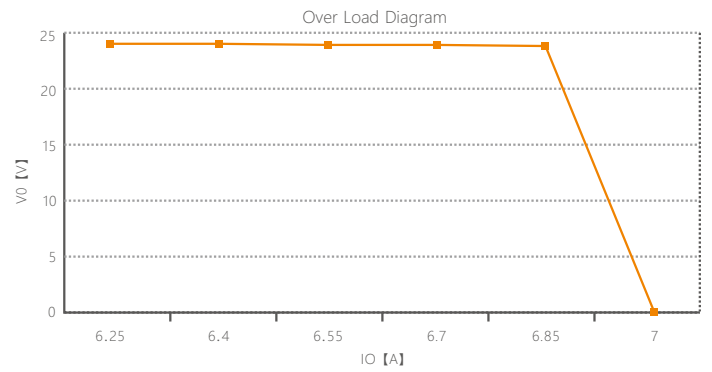
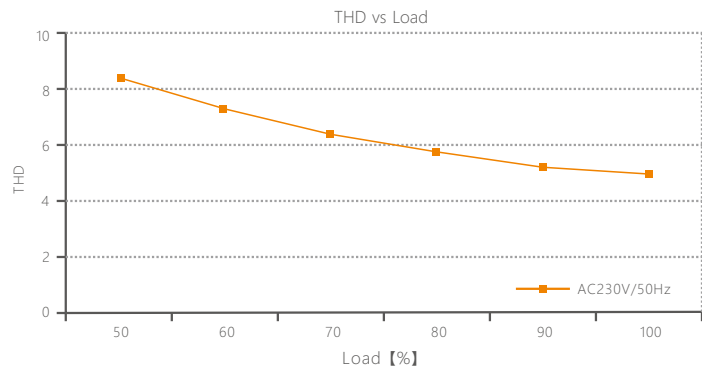
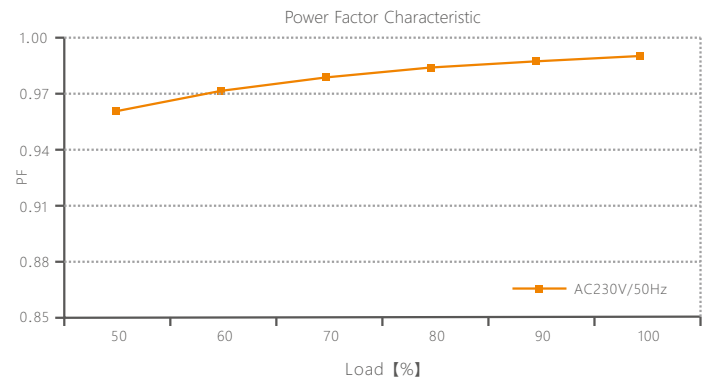
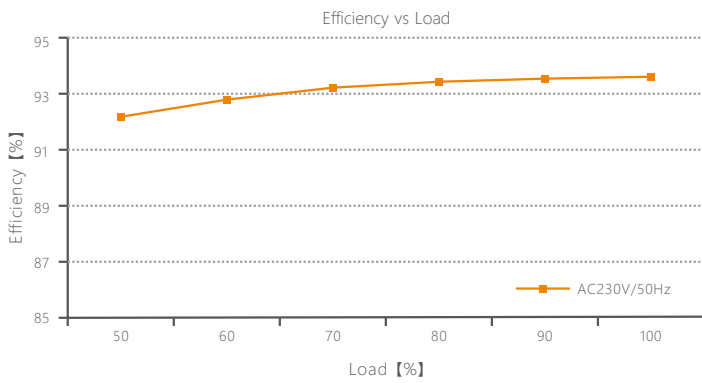

LM-150-24-G1M2

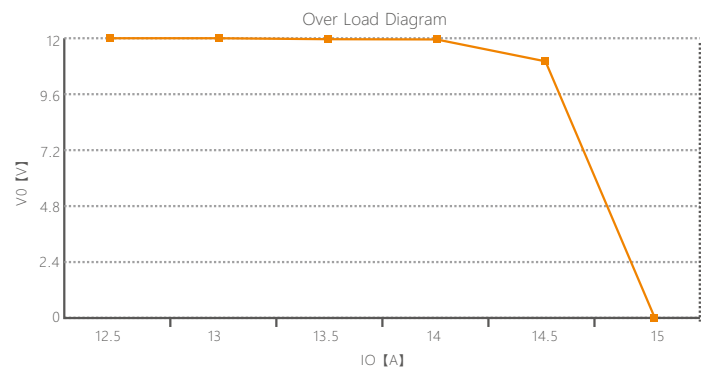
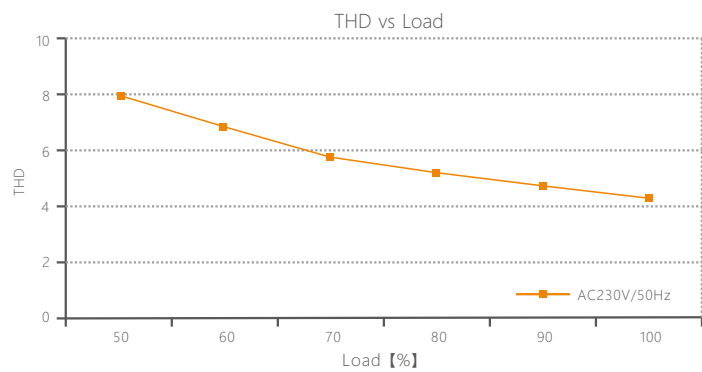
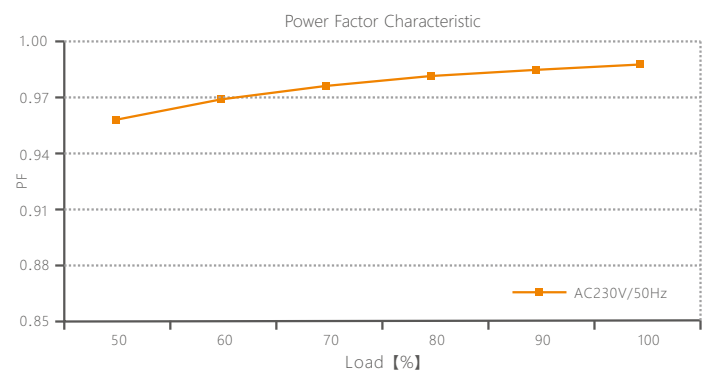
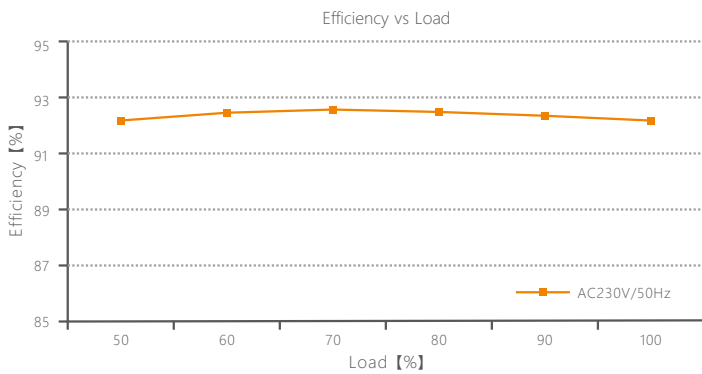

LM-150-12-G1M2

Flicker Test Form

IEEE 1789

Limit of Modulation in low risk area	
Waveform frequency of Optical output	limit (%)
$f \leq 8\text{Hz}$	0.2
$8\text{Hz} < f \leq 90\text{Hz}$	$0.025 \times f$
$90\text{Hz} < f \leq 1250\text{Hz}$	$0.08 \times f$
$f > 1250\text{Hz}$	Exemption assessment
Limit of Modulation in no effect area	
Waveform frequency of Optical output	limit (%)
$f \leq 10\text{Hz}$	0.1
$10\text{Hz} < f \leq 90\text{Hz}$	$0.01 \times f$
$90\text{Hz} < f \leq 3125\text{Hz}$	$[0.08/2.5] \times f$
$f > 3125\text{Hz}$	Exemption assessment (High frequency exemption)

Brightness

- ▲ 0.1%
- ◆ 1%
- ▲ 5%
- ◆ 10%
- 20%
- ▲ 30%
- 40%
- ★ 50%
- 60%
- 70%
- ☆ 80%
- ◆ 90%
- ◆ 100%

Exemption assessment
(High frequency exemption)

